



ASSA ABLOY



ASSA ABLOY

soluzioni per la
vostra sicurezza



Chiudiporta



Maniglioni



ENTR



Incontri elettrici



Digital Door Viewers



ASSA ABLOY

www.assaabloy.it

The global leader in
door opening solutions

**SERRATURA AD INFILARE
MODELLO TREPPER
CON SCROCCO E CATENACCIO
BASCULANTE
FRONTALE INOX MM. 22
ART. 98010-080**

103935 ENT. MM. 25
103936 ENT. MM. 30
103937 ENT. MM. 35



**SERRATURA AD INFILARE
TRIPLICE MODELLO TREPPER
CON SCROCCO E CATENACCIO
BASCULANTE
FRONTALE INOX MM. 22
ART. 98014-080**

103938 ENT. MM. 25
103939 ENT. MM. 30
103940 ENT. MM. 35



**RULLO PER SERRATURA
MODELLO TREPPER
ART.498010-000**

103951 ENT. MM. 25
103952 ENT. MM. 30
103953 ENT. MM. 35

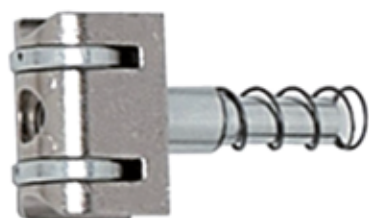

**CILINDRO A SPILLO
PER SERRATURA
MODELLO TREPPER**

103955 ART. 6808



**SERRATURA AD INFILARE
AVANZAMENTO MECCANICO
MODELLO AVANT
FRONTALE INOX MM. 22
ART. F7651P**

104670 ENT. MM. 25

104671 ENT. MM. 30

104672 ENT. MM. 35



**SERRATURA AD INFILARE
AVANZAMENTO MECCANICO
TRIPLICE
MODELLO AVANT
FRONTALE INOX MM.22
ART. F7653P**

104673 ENT. MM. 25

104674 ENT. MM. 30

104675 ENT. MM. 35



**SERRATURA ELETTRICA
INFILARE AD AVANZAMENTO
MECCANICO
FRONTALE INOX MM. 22
ART. 7751P**

104676 ENT. MM. 25

104677 ENT. MM. 30

104678 ENT. MM. 35



**SERRATURA ELETTRICA
INFILARE AD AVANZAMENTO
MECCANICO
TRIPLICE
FRONTALE INOX MM. 22
ART. 7753P**

104679 ENT. MM. 25

104680 ENT. MM. 30

104681 ENT. MM. 35



**SERRATURA AD INFILARE
DOPPIA MAPPA
FRONTALE INOX MM. 25
ART. 6601**

103924 ENTRATA MM. 23



**SERRATURA AD INFILARE
DOPPIA MAPPA
TRIPLICE
FRONTALE INOX MM. 25
ART. 6603**

103925 ENTRATA MM. 23



**SERRATURA ELETTRICA
INFILARE DOPPIA MAPPA
FRONTALE INOX MM. 25
ART. 6701**

103932 ENTRATA MM. 23



**SERRATURA ELETTRICA
INFILARE DOPPIA MAPPA
TRIPLICE
FRONTALE INOX MM. 25
ART. 6703**

103933 ENTRATA MM. 23

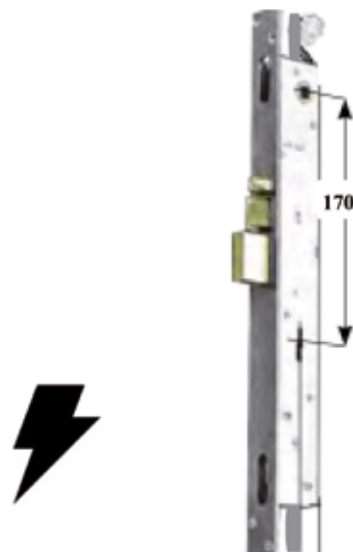

**SERRATURA AD INFILARE
DOPPIA MAPPA TRIPLICE
FRONTALE INOX MM. 25
ART. 6873**

103920 ENTRATA MM. 70



**SERRATURA AD INFILARE
DOPPIA MAPPA TRIPLICE
FRONTALE INOX MM. 25
ART. 6893**

103921 ENTRATA MM. 90



**SERRATURA AD INFILARE
DOPPIA MAPPA TRIPLICE
ELETTRICA
FRONTALE INOX MM. 25
ART. 6973**

103922 ENTRATA MM. 70

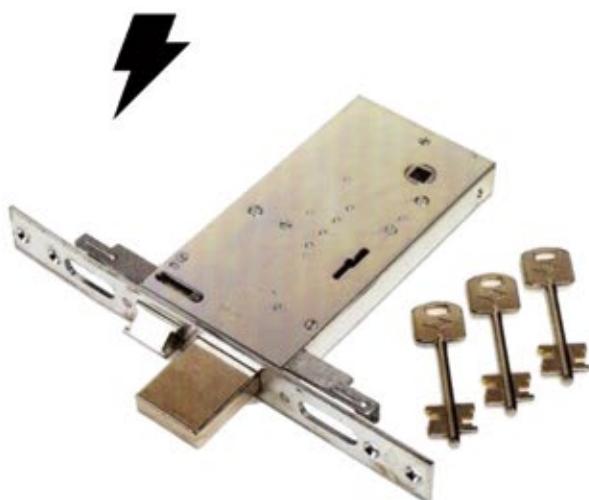

**SERRATURA AD INFILARE
DOPPIA MAPPA TRIPLICE
ELETTRICA
FRONTALE INOX MM. 25
ART. 6993**

103923 ENTRATA MM. 90

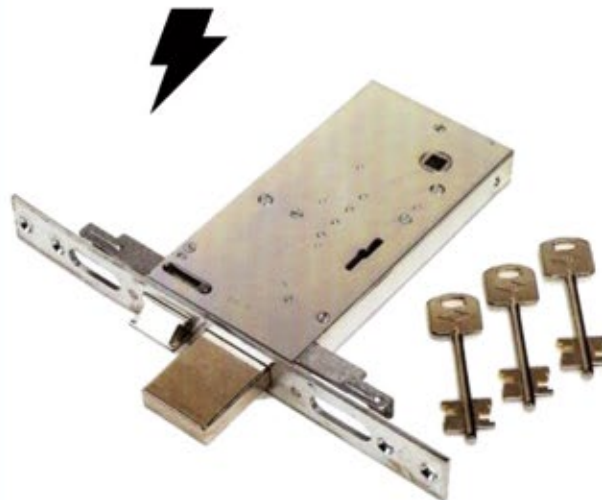

**SERRATURA ELETTRICA
REVERSIBILE E REGOLABILE
MULTIPLA
ART. F.5011/1Z**

130120 ENT. MM. 50-60-70



**SERRATURA ELETTRICA
IN ACCIAIO VERNICIATO
SOLO SCROCCO
ART. 680**

103980 ENT. MM. 60 DX

103981 ENT. MM. 60 SX

103982 ENT. MM. 70 DX

103983 ENT. MM. 70 SX



**SERRATURA ELETTRICA
IN ACCIAIO VERNICIATO
SOLO SCROCCO C/ PULSANTE
ART. 684**

103984 ENT. MM. 60 DX

103985 ENT. MM. 60 SX

103986 ENT. MM. 70 DX

103987 ENT. MM. 70 SX

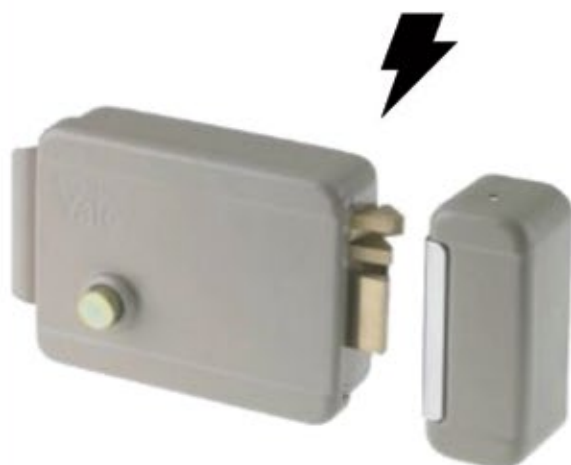

**BOBINA DI RICAMBIO
PER SERRATURE
SERIE 680-684
ART. 06701**

103988 DX

103989 SX

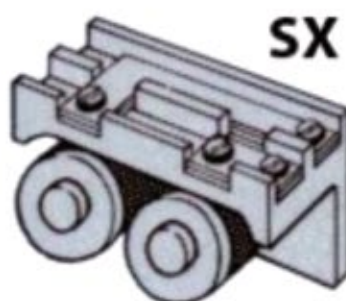

**SERRATURA DA PORTONCINO
CILINDRO FISSO
2 MANDATE
ART. 63000**

104682 ENT. MM. 50 DX
104683 ENT. MM. 50 SX
104684 ENT. MM. 60 DX
104685 ENT. MM. 60 SX
104686 ENT. MM. 70 DX
104687 ENT. MM. 70 SX



**SERRATURA DA PORTONCINO
CILINDRO FISSO
2 MANDATE
CON FORO MANIGLIA
ART. 63060**

104688 ENT. MM. 60 DX
104689 ENT. MM. 60 SX



**SERRATURA AD INFILARE
BORDO RETTO
OTTONATA REVERSIBILE
ART. 520**

103971 ENT. MM. 40
103973 ENT. MM. 50
103974 ENT. MM. 60



**SERRATURA AD INFILARE
ELETTRICA
BORDO RETTO
REVERSIBILE
ART. 580**

103975 ENT. MM. 40
103976 ENT. MM. 50
103977 ENT. MM. 60



**SERRATURA AD APPLICARE
 CON CILINDRO STACCATO**
**GIRI 5 1/2
ART. 66052**
103960 ENT. MM. 50
103961 ENT. MM. 60

**SERRATURA AD APPLICARE
 CON CILINDRO FISSO**
**GIRI 5 1/2
ART. 66151**
103962 ENT. MM. 50
103963 ENT. MM. 60

**SERRATURA AD APPLICARE
 CON CILINDRO STACCATO**
**GIRI 6
ART. 66062**
103964 ENT. MM. 50
103965 ENT. MM. 60

**SERRATURA AD APPLICARE
 CON CILINDRO ATTACATO**
**GIRI 6
ART. 66161**
103966 ENT. MM. 50
103967 ENT. MM. 60
**103968 CONTROP. ART. 066014
 X SERRATURE SERIE
 660-661 VERN. NERO**

**SERRATURA DOPPIA MAPPA
MODELLO TRAK CORNI
ART. 91004**

103995 ENT. MM. 52
103996 ENT. MM. 60
103997 ENT. MM. 70



**APRIPORTA ELETTRICO
AD APPLICARE
ART. 500/5-6**

103118 500/5 DESTRO
103119 500/6 SINISTRO



**SERRATURA PER PORTA
BLINDATA
CON DOPPIA FUNZIONE
ART. 133Y865180**

104690 DESTRA



**SERRATURA PER PORTA
BLINDATA
CON DOPPIA FUNZIONE
ART. 133Y865280**

104691 SINISTRA



**SERRATURA AD APPLICARE
ELETTRICA TRIPLICE
A POMPA MM. 60 SEGRETA
ART. 6823.60**

**103121 DESTRA
103122 SINISTRA**

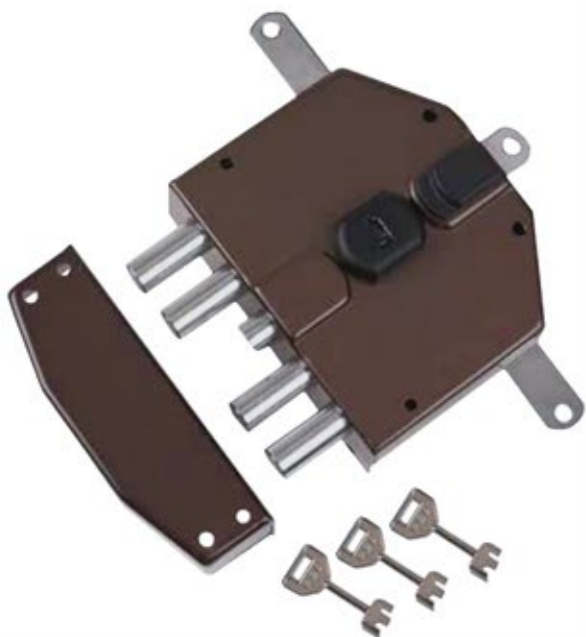

**CILINDRO A POMPA
PER SERRATURE SERIE 6823
ART. 8360**

103124 MM. 60



**COPPIA ASTE
PER SERRATURE SERIE 6823
ART. 8318**

103123 REGOLABILI



**BOBINA DI RICAMBIO
PER SERRATURE SERIE 6823
ART. 806**

103135 COMPLETA



**MANIGLIONE ANTIPANICO
VERNICIATO NERO
SCROCCO IN ZAMA
MODELLO MINISTAR**

104692 ART. 42906

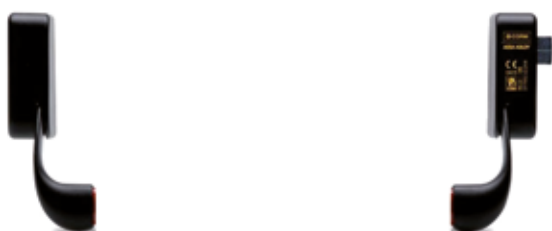

**BARRA DI SPINTA OVALE
VERNICIATO ROSSO
MM. 1200
MODELLO MINISTAR**

104693 ART. 260002



**COPPIA SCROCCHI
PER ANTIPANICO
PER CHIUSURA VERTICALE
VERNICIATO NERO
SCROCCHI IN ZAMA
MODELLO MINISTAR**

104694 ART. 03429



**ASTE PER ANTIPANICO
PER CHIUSURA VERTICALE
VERNICIATO NERO
ALTEZZA MASSIMA CM 240
MODELLO MINISTAR**

104695 ART. 044401



**MANIGLIA E CILINDRO
PER ANTIPANICO
VERNICIATO NERO
PER MINISTAR
MOD. JOLLY**

104696 ART. 0448008



**INCONTRO ELETTRICO
PER ANTIPANICO
VERNICIATO NERO**

104697 ART. 16501/1



**CHIUDIPIORTA
ASSA ABLOY
FORZA 2-3-4 NERO
SERIE DC 120**

**103942 SENZA FERMO
103943 CON FERMO**



**CHIUDIPIORTA
ASSA ABLOY
FORZA 2-3-4 ARGENTO
SERIE DC 120**

**103944 SENZA FERMO
103945 CON FERMO**



**SERRATURA PER FASCIA
SCROCCO REVERSIBILE
1 MANDATA
NEW SILVER**

104191 8700058080 ENT. MM. 58



**FRONTALE MM. 16
ALTEZZA SCATOLA MM. 44**

**SERRATURA PER FASCIA
SCROCCO REVERSIBILE
2 MANDATE
NEW SILVER**

104189 870027080 ENT. MM. 70

104190 870028080 ENT. MM. 80



**FRONTALE MM. 16
ALTEZZA SCATOLA MM. 44
CONFEZIONE INDUSTRIALE**

**SERRATURA PER FASCIA
SCROCCO REVERSIBILE
2 MANDATE
NEW SILVER**

104180 8600058080 ENT. MM. 58

104183 8600070080 ENT. MM. 70



**FRONTALE MM. 16
ALTEZZA SCATOLA MM. 78**

**SERRATURA PER FASCIA
SCROCCO REVERSIBILE
3 MANDATE
NEW SILVER**

104181 8600270080 ENT. MM. 70

104182 8600280080 ENT. MM. 80



**FRONTALE MM. 16
ALTEZZA SCATOLA MM. 78**

**ELETTROSERRATURA
PER FASCIA
SOLO SCROCCO
REVERSIBILE NEW SILVER**

104188 854007080 ENT. MM. 70

104192 854008080 ENT. MM. 80



**FRONTALE MM. 16
ALTEZZA SCATOLA MM. 44**

**ELETTROSERRATURA
PER FASCIA
SOLO SCROCCO
REVERSIBILE NEW SILVER**

104184 8500058080 ENT. MM. 58

104185 8500070080 ENT. MM. 70



**FRONTALE MM. 16
ALTEZZA SCATOLA MM. 78**

**ELETTROSERRATURA
PER FASCIA
2 MANDATE E SCROCCO
REVERSIBILE NEW SILVER**

104187 8520070080 ENT. MM. 70



**FRONTALE MM. 16
ALTEZZA SCATOLA MM 78**

**ELETTROSERRATURA
PER FASCIA
3 MANDATE E SCROCCO
REVERSIBILE NEW SILVER**

104186 8520280080 ENT. MM. 80



**FRONTALE MM. 16
ALTEZZA SCATOLA MM. 78**

ASSA ABLOY

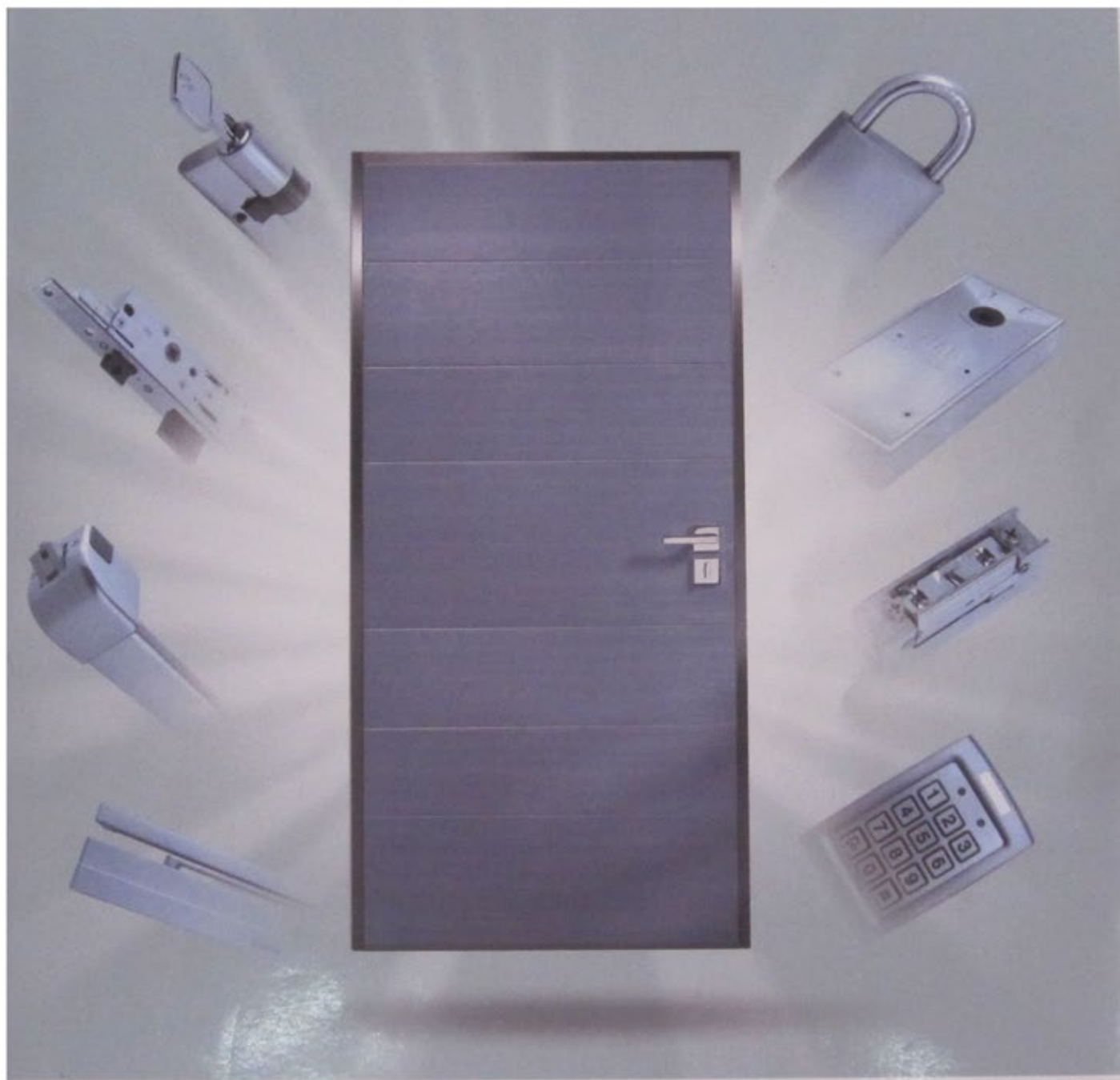

Atra

Dierre
YOUR HOME, YOUR LIFE



THE ITALIAN STYLE DOOR

Dierre

YOUR HOME, YOUR LIFE

SOLUZIONI SICURE, SOLUZIONI DA LEADER.



AFFIDATI ALLA SICUREZZA ED AL DESIGN DIERRE
PER ACCESSORI & RICAMBI.
DIERRE . LA TUA CASA , LA TUA VITA .

www.dierre.com





**SERRATURA DOPPIA MAPPA
TRIPLICE ENTRATA MM 60
CON BLOCC. CHIAVE MM 92**

**103172 ART. 6111
MM. 60 DX**

**103172 ART. 6112
MM. 60 SX**

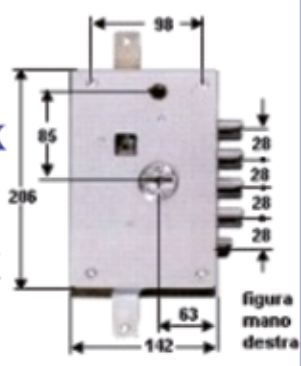

**SERRATURA DOPPIA MAPPA
TRIPLICE ENTRATA MM. 70
CON BLOCC. CHIAVE MM 92**

**103175 ART. 7111
MM. 70 DX**

**103176 ART. 7112
MM. 70 SX**

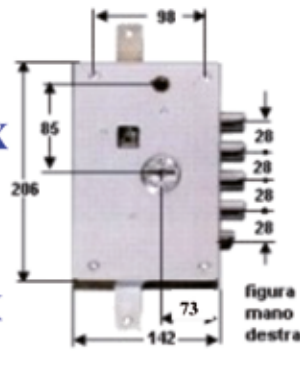

**SERRATURA APPLICARE
PREDISP. CIL. EUROPEO
ART. NE 72
REVERSIBILE**

103252 MM. 60



**SERRATURA APPLICARE
PREDISP. CIL. EUROPEO
ART. NE 72
REVERSIBILE**

103253 MM. 70





Dierre

Atra

**SERRATURA DA APPLICARE
DOPPIA MAPPA**

104650 ART. 1121 DX

104651 ART. 1122 SX

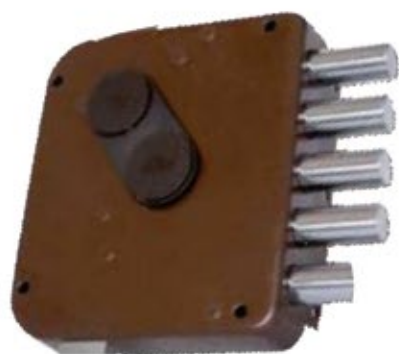

**SERRATURA DA APPLICARE
TRIPLICE
DOPPIA MAPPA**

104652 ART. 3121 DX

104653 ART. 3122 SX



**SERRATURA DA APPLICARE
QUINTUPLICE
DOPPIA MAPPA**

104654 ART. 5121 DX

104655 ART. 5122 SX



**BLOCCHETTO ATRA
CON 3 CHIAVI**

103177 ART. 3110 CHIAVI MM. 92

103178 ART. 3210 CHIAVI MM.116





Dierre

Atra

**KIT CONVERSIONE SICURA
PER PORTA BLINDATA DIERRE
CON SERRATURA A CILINDRO EUROPEO
REVERSIBILE**

103790 MM. 60

103791 MM. 70



CONFEZIONE KIT:

**N.1 SERRATURA CILINDRO NE 42
N. 1 CILINDRO FRIZIONATO NEW POWER 30/50 CON 5 CHIAVI PROTETTE
KIT PER RIDIMENSIONAMENTO CILINDRO
MOSTRINE COLORE BRONZO CON RELATIVO KIT DI FISSAGGIO
DEFENDER E ACCESSORI DI COLORE BRONZO
N.1 BOMBOLETTA D-FLU LUBRIFICANTE PER SERRATURE**

**KIT CONVERSIONE SICURA
PER PORTA BLINDATA DIERRE
CON SERRATURA A CILINDRO EUROPEO
CILINDRO CON CODOLO
REVERSIBILE**

103792 MM. 60

103793 MM. 70



CONFEZIONE KIT:

**N.1 SERRATURA CILINDRO NE 42
N. 1 CILINDRO FRIZIONATO NEW POWER 30/30/49 CON 5 CHIAVI PROTETTE
KIT PER RIDIMENSIONAMENTO CILINDRO
MOSTRINE COLORE BRONZO CON RELATIVO KIT DI FISSAGGIO
DEFENDER E ACCESSORI DI COLORE BRONZO
N.1 BOMBOLETTA D-FLU LUBRIFICANTE PER SERRATURE**



WWW.SAMEFERRAMENTA.COM









**SERRATURA INFILARE
“PATENT”
BRONZATE BORDO RETTO
CON CONTROPIASTRA**

- 103216 E MM. 30
- 103217 E MM. 35
- 103218 E MM. 40
- 103219 E MM. 45
- 103220 E MM. 50
- 103221 E MM. 60



**SERRATURA INFILARE
“PATENT”
BRONZATE BORDO TONDO
CON CONTROPIASTRA**

- 103224 E MM 40
- 103225 E MM 45
- 103226 E MM 50



**SERRATURA INFILARE
“PATENT”
OTTONATE BORDO RETTO
CON CONTROPIASTRA**

- 103228 E MM. 30
- 103229 E MM. 35
- 103230 E MM. 40
- 103231 E MM. 45
- 103232 E MM. 50
- 103233 E MM. 60



**SERRATURA INFILARE
“PATENT”
OTTONATE BORDO TONDO
CON CONTROPIASTRA**

- 103236 E MM. 40
- 103237 E MM. 45
- 103238 E MM. 50



**SERRATURA INFILARE
“PATENT”
OTTONATO BORDO TONDO
DISTANZA MM. 90**

- 103845 MM. 50

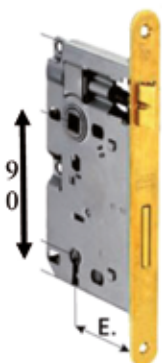

**SERRATURA INFILARE
“PATENT”
CROMO SAT. BORDO TONDO
DISTANZA MM. 90**

- 103846 MM. 50

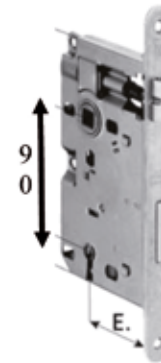



**SERRATURA INFILARE
"PATENT"
CROMO OPACO BORDO RETTO
CON CONTROPIASTRA**

103257 E. MM 50



**SERRATURA INFILARE
"PATENT"
CROMO OPACO BORDO TONDO
CON CONTROPIASTRA**

103258 E. MM. 50



**SERRATURA INFILARE
"PATENT"
NICHELATA LUC. BORDO RETTO
CON CONTROPIASTRA**

103240 E. MM. 50



**SERRATURA INFILARE
"PATENT"
NICHELATA LUC. BORDO TONDO**

103241 E. MM. 50



**SERRATURA INFILARE "PATENT"
OTTONATO BORDO TONDO
CILINDRO SAGOMATO
C/CONTROPIASTRA**

103242 E. MM. 50



**SERRATURA INFILARE "PATENT"
MAGNETICA
BORDO TONDO
C/ CONTROPIASTRA**

**103824 E.50 CR. SAT.
103825 E.50 OTT**





**SERRATURA INFILARE
"PATENT"
B-BITTER
SCROCCO NYLON
CON CONTROPIASTRA**

103830 E. 50 OTT.



**SERRATURA INFILARE
"PATENT"
B-BITTER
SCROCCO NYLON
CON CONTROPIASTRA**

**103831 E. 50 CROMO
OPACO**

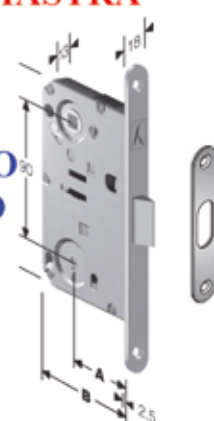

**SERRATURA INFILARE
"PATENTONA"
OTTONATA BORDO RETTO
CON CONTROPIASTRA**

103810 E. MM. 50

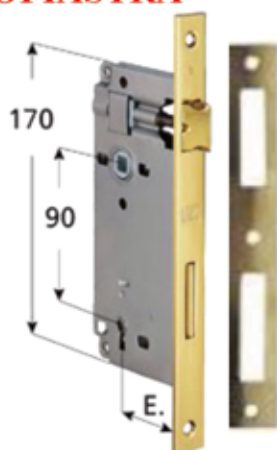

**SERRATURA INFILARE
"PATENTONA"
OTTONATA BORDO TONDO
CON CONTROPIASTRA**

103811 E. MM. 50

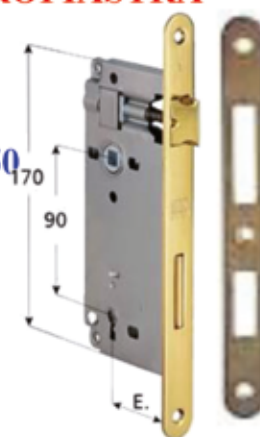

**SERRATURA INFILARE
"PATENTONA"
CROMO OPACO BORDO RETTO
CON CONTROPIASTRA**

103812 E. MM.50

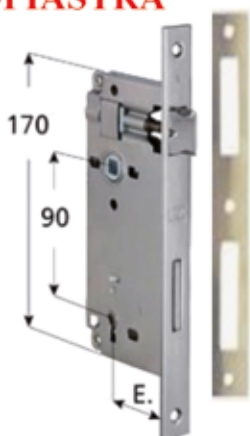

**SERRATURA INFILARE
"PATENTONA"
CROMO OPACO BORDO TONDO
CON CONTROPIASTRA**

103813 E. MM. 50





**SERRATURA INFILARE
A GANCIO ART. 60
CON CHIAVE**

103832 OTT.LUC.
103833 CR. SAT.
103834 BRONZ.

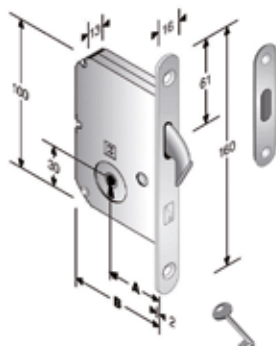

**SERRATURA INFILARE
A GANCIO ART. 61
FORO MANIGLIA**

103835 OTT.LUC.
103836 CR. SAT.
103837 BRONZ.

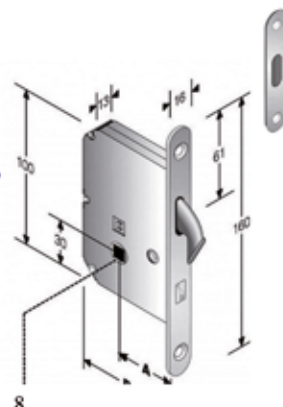

**KIT PORTA SCORREVOLE
CON CHIAVE**

103838 OTT.LUC.
103839 CR. SAT.
103840 BRONZ.



**KIT PORTA SCORREVOLE
CON FORO MANIGLIA**

103841 OTT.LUC.
103842 CR. SAT.
103943 BRONZ.



**SERRATURA APPLICARE
BRONZATA VERTICALE
ART. 185**

103815 MM. 60 DX
103816 MM. 60 SX
103817 MM. 70 DX
103818 MM. 70 SX
103819 MM. 80 DX
103820 MM. 80 SX

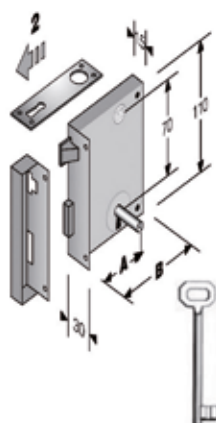

**SERRATURA APPLICARE
BRONZATA ORIZZONTALE
SOLO SCROCCO
ART. 189**

103821 MM. 60 DX
103822 MM. 70 DX
103823 MM. 80 DX





SERRATURE DI SICUREZZA

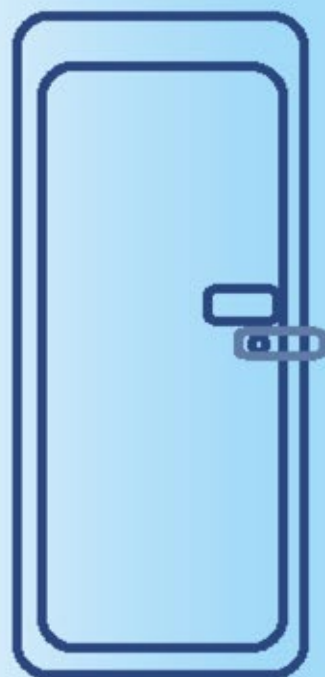

WWW.SAMEFERRAMENTA.COM





**CILINDRO CHIUSURA FORO
PER SERRATURA PATENT
C/2 CHIAVI**



103990 ART. E 6/2



**CILINDRO CHIAVE A SPILLO
RAGGIO MM. 16.5
C/3 CHIAVI**



103991 ART. 10/3



LOCKS & KEYS

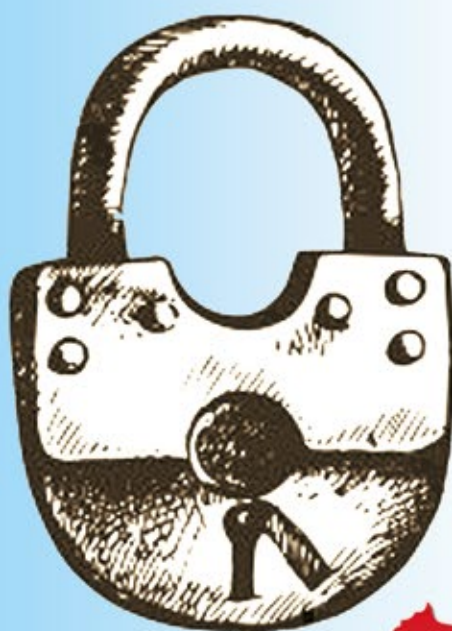

Cerutti





Cerutti®

tradizione di sicurezza da oltre settanta anni



CILINDRO A POMPA

104504 L MM. 50
104505 L MM. 60
104506 L MM. 70



**SERRATURA AD INFILARE
TRIPLICE ART. 1031**

104523 E. 60

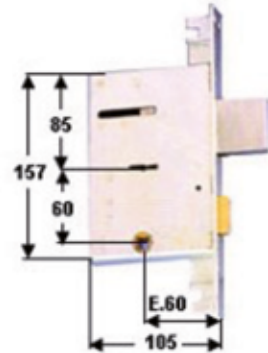

SERRATURA AD INFILARE

104517 E.50 2024
104518 E.60 3028
104519 E.70 3030

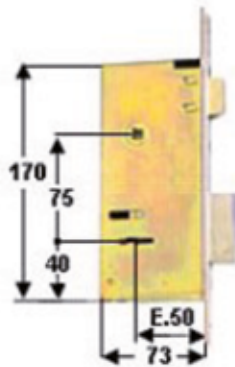

**SERRATURA AD INFILARE
TRIPLICE**

104520 E.50 2032
104521 E.60 3036
104522 E.70 3038
104534 E.60 2036

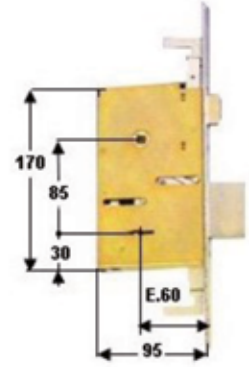

**SERRATURA AD APPLICARE
TRIPLICE ART. 4000**

104524 DESTRA
104525 SINISTRA

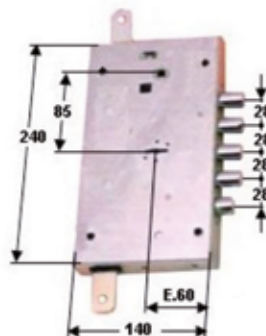

**SERRATURA AD APPLICARE
TRIPLICE ART. 4037
CON 3 CHIAVISTELLI**

104526 DESTRA
104527 SINISTRA



**SERRATURA AD APPLICARE
TRIPLICE ART. 9004**

**104528 DESTRA
104529 SINISTRA**

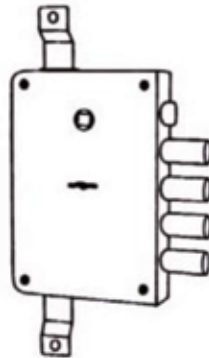

**SERRATURA AD INFILARE
TRIPLICE ART. 9010**

**104530 DESTRA
104531 SINISTRA**



**SERRATURA AD INFILARE
TRIPLICE ART. 9510**

**104532 DESTRA
104533 SINISTRA**

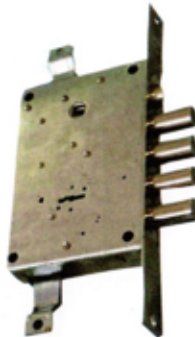

**SERRATURA AD APPLICARE
ART. 9206**

**104507 DESTRA
104508 SINISTRA**

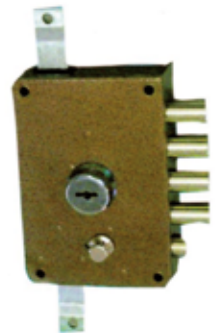

**SERRATURA AD APPLICARE
TRIPLICE SERIE "CAMPION"
ART. 1016**

**104500 DESTRA
104501 SINISTRA**



**SERRATURA AD APPLICARE
QUINTUPLICE SERIE "CAMPION"
ART. 2116**

**104502 DESTRA
104503 SINISTRA**

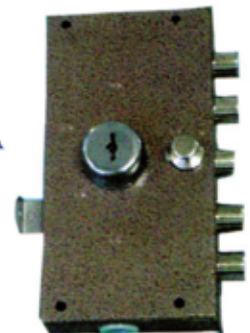

**SERRATURA AD APPLICARE
TRIPLICE SERIE BULLDOG
ART. 1008**

**104509 DESTRA
104510 SINISTRA**

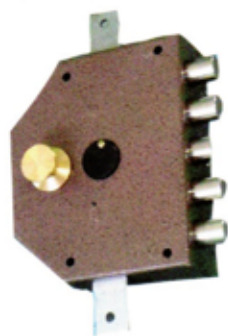

**SERRATURA AD APPLICARE
QUINTUPLICE SERIE BULLDOG
ART.2108**

**104511 DESTRA
104512 SINISTRA**

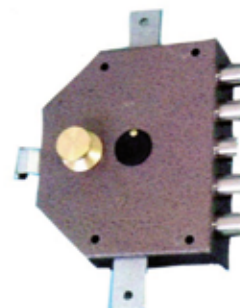

**ASTE PER TRIPLICE
PER SERRATURA CAMPION**

104513 C/ACC.



**ASTE PER TRIPLICE
PER SERRATURA BULLDOG**

104515 C/ACC.



**ASTE E DEVIATORE
PER QUINTUPLICE
SERIE CAMPION**

104514 C/ACC.



**ASTE E DEVIATORE
PER QUINTUPLICE
SERIE BULLDOG**

104516 C/ACC.



**SERRATURA AD APPLICARE
TRIPLICE ART. 7037
CON 3 CHIAVISTELLI
PREDISPOSIZIONE
CILINDRO EUROPEO
REVERSIBILE**

104535

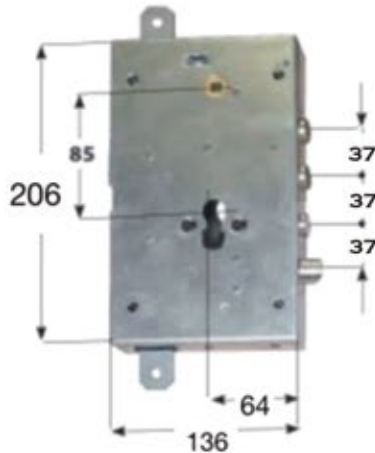

**SERRATURA INFILARE
TRIPLICE ART. 2036 CE
CON PREDISPOSIZIONE
CILINDRO EUROPEO
REVERSIBILE**

104536 E.60

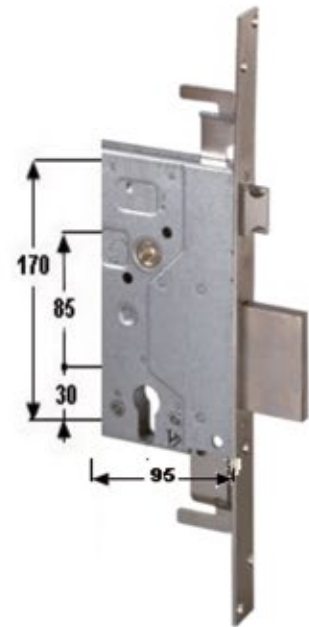

**SERRATURA AD APLICARE
TRIPLICE SERIE "CAMPION"
ART. 1016 CE
CON PREDISPOSIZIONE
CILINDRO EUROPEO
REVERSIBILE**

104537



**SERRATURA AD APPLICARE
QUINTUPLICE SERIE "CAMPION"
ART. 2116 CE
CON PREDISPOSIZIONE
CILINDRO EUROPEO
REVERSIBILE**

104538

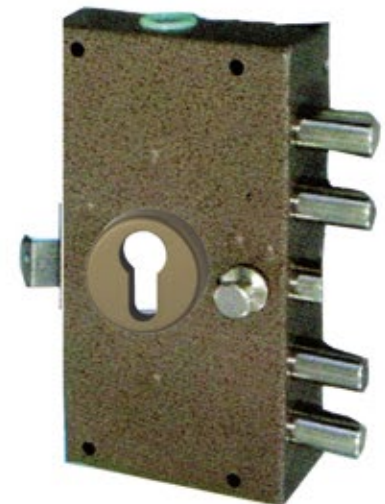



CIPIERRE

sicurezza in casa





CIPIERRE

sicurezza in casa



**SERRATURA INFILARE
TRIPLICE A CILINDRO
90128
REVERSIBILE
SISTEMA ANTIMANIPOLAZIONE**

104380 ENT.60/28
104381 ENT.70/28



**SERRATURA INFILARE
TRIPLICE A CILINDRO
90137
REVERSIBILE
SISTEMA ANTIMANIPOLAZIONE**

104382 ENT.60/37
104383 ENT.70/37



**SERRATURA INFILARE
TRIPLICE A CILINDRO
50128**

104387 ENT.60/28



**SERRATURA INFILARE
TRIPLICE A CILINDRO
50137**

104388 ENT.60/37



**SERRATURA INFILARE
TRIPLICE DOPPIO CILINDRO
90228
REVERSIBILE**

104384 ENT.60/28
104385 ENT.70/28





CISA®





CISA





**ELETTROSERRATURA
DA APPLICARE
ELETTRIKA
PER CANCELLI REVERSIBILE
ART.1A721**

180055 1A721.00.0



**ELETTROSERRATURA
DA APPLICARE
ELETTRIKA
PER CANCELLI REVERSIBILE
C/PULSANTE
ART.1A731**

180056 1A731.00.0



**ELETTROSERRATURA
DA APPLICARE
SOLO SCROCCO
ART.11721**

180000 11721.50.1
180001 11721.50.2
180002 11721.60.1
180003 11721.60.2
180004 11721.70.1
180005 11721.70.2
180006 11721.80.1
180007 11721.80.2



**ELETTROSERRATURA
DA APPLICARE
SCROCCO E PULSANTE
ART.11731**

180010 11731.50.1
180011 11731.50.2
180012 11731.60.1
180013 11731.60.2
180014 11731.70.1
180015 11731.70.2
180016 11731.80.1
180017 11731.80.2



**ELETTROSERRATURA
DA APPLICARE
SCROCCO E MANDATE
ART.11761**

180020 11761-50-1
180021 11761-50-2
180022 11761-60-1
180023 11761-60-2
180024 11761-70-1
180025 11761-70-2
180026 11761-80-1
180027 11761-80-2



**ELETTROSERRATURA
DA APPLICARE
SCROCCO MAND. E PULSANTE
ART.11771**

180030 11771-50-1
180031 11771-50-2
180032 11771-60-1
180033 11771-60-2
180034 11771-70-1
180035 11771-70-2
180036 11771-80-1
180037 11771-80-2



**ELETTROSERRATURA
DA APPLICARE
PER CANCELLI AUTOMATICI
E BASCULANTI
SCROCCO ROVESCciato
ART.11921**

180040 11921-60-3
180041 11921-60-4
180042 11921-70-3
180043 11921-70-4



**ELETTROSERRATURA
DA APPLICARE
PER CANCELLI AUTOMATICI
E BASCULANTI
SCROCCO ROVESCciato C/PULS
ART.11931**

180044 11931-60-3
180045 11931-60-4
180046 11931-70-3
180047 11931-70-4



**SERRATURA
DA APPLICARE
ART.50461**

180200 50461-50-1

180201 50461-50-2



**SERRATURA
DA APPLICARE
CON FORO MANIGLIA
ART.50471**

180210 50471-60-1

180211 50471-60-2

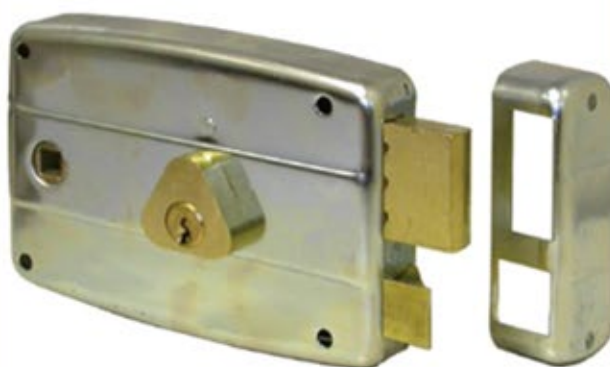

**SERRATURA
DA APPLICARE
ART.50421**

180190 50421-60-1

180191 50421-60-2

180192 50421-70-1

180193 50421-70-2

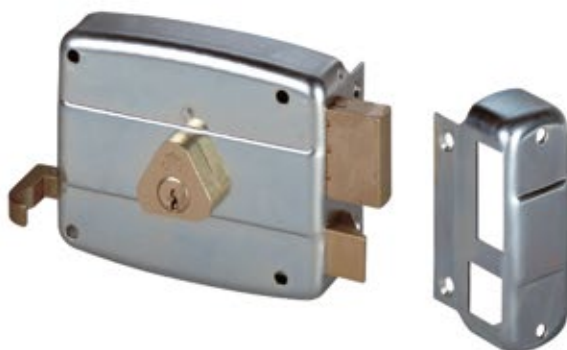

**SERRATURA INFILARE
DOPPIA MAPPA
4 MANDATE
ART.57013 KA**

180064 57013-60

180065 57013-70

180400 57013-60 KA

180401 57013-70 KA



ALTEZZA SCATOLA MM. 82

**SERRATURA INFILARE
DOPPIA MAPPA TRIPLICE
4 MANDATE
ART.57016**

180066 57016-60
180067 57016-70



ALTEZZA SCATOLA MM. 82

**SERRATURA INFILARE
DOPPIA MAPPA TRIPLICE
4 MANDATE
ART.57016 KA**

180410 57016 60 KA
180411 57016 70 KA



ALTEZZA SCATOLA MM. 82

**SERRATURE INFILARE
DOPPIA MAPPA
4 MANDATE
ART.57223**

180068 57223-50



ALTEZZA SCATOLA MM. 93

**SERRATURE INFILARE
DOPPIA MAPPA TRIPLICE
4 MANDATE
ART.57226**

180069 57226-50



ALTEZZA SCATOLA MM. 93

**SERRATURA INFILARE
DOPPIA MAPPA
4 MANDATE E SCROCCO
ART.57313**

180110 57313-73



ALTEZZA SCATOLA MM. 82

**SERRATURA INFILARE
DOPPIA MAPPA
4 MANDATE E SCROCCO
TRIPLICE
ART.57318**

180145 57318-73



ALTEZZA SCATOLA MM. 82

**SERRATURA INFILARE
DOPPIA MAPPA
4 MANDATE E SCROCCO
ART.57353**

180111 57353-90



ALTEZZA SCATOLA MM. 78

**SERRATURA INFILARE
DOPPIA MAPPA
4 MANDATE E SCROCCO
TRIPLICE
ART. 57358**

180146 57358-90



ALTEZZA SCATOLA MM. 78

**SERRATURA INFILARE
ELETTRICA
DOPPIA MAPPA
ART.17353-90**

180070 17353-90



ALTEZZA SCATOLA MM. 78

**SERRATURA INFILARE
ELETTRICA
DOPPIA MAPPA
TRIPLICE
ART. 17358**

180071 17358-90



ALTEZZA SCATOLA MM. 78

**SERRATURA INFILARE
A CILINDRO SAGOMATO
3 MANDATE
ART. 56013**

**180060 56013-60
180061 56013-70**



ALTEZZA SCATOLA MM. 82

**SERRATURA INFILARE
A CILINDRO SAGOMATO
3 MANDATE TRIPLICE
ART 56016**

**180062 56016-60
180063 56016-70**



ALTEZZA SCATOLA MM. 82

**SERRATURA INFILARE
A CILINDRO PER PERSIANE
TRIPLICE
CATENACCIO BASCULANTE
ART.46800 INOX**

180120 46300-25
180121 46300-30
180122 46300-35



**SERRATURA INFILARE
A CILINDRO PER PERSIANE
TRIPLICE
A GANCIO
ART.46865**

180420 46865-25
180421 46865-30
180422 46865-35



**SERRATURA INFILARE
A CILINDRO PER PERSIANE
CATENACCIO
E SCROCCO REVERSIBILE
ART. 46815**

180423 46815-25
180424 46815-30
180425 46816-35



**SERRATURA INFILARE
A CILINDRO PER PERSIANE
TRIPLICE
CATENACCIO
E SCROCCO REVERSIBILE
ART. 46225**

180460 46225-25
180461 46225-30
180462 46225-35



**SERRATURA INFILARE
CILINDRO OVALE
ART. 44150**

180080 44150-60
180081 44150-70 C. IND.
180082 44150-80 C. IND



ALTEZZA SCATOLA MM. 44

**SERRATURA INFILARE
CILINDRO OVALE
ART. 44460**

180078 44460-70
180079 44460-80



ALTEZZA SCATOLA MM. 77

**SERRATURA INFILARE
ELETTRICA
CILINDRO SAGOMATO
ART. 14010**

180072 14010-60-1
180073 14010-60-2



ALTEZZA SCATOLA MM. 82

**SERRATURA INFILARE
ELETTRICA
CILINDRO SAGOMATO
ART. 14350**

180074 14350-70
180075 14350-80



ALTEZZA SCATOLA MM. 77

**SERRATURA INFILARE
ELETTRICA
CILINDRO OVALE
ART.14450**

180076 14450-70
180077 14450-80

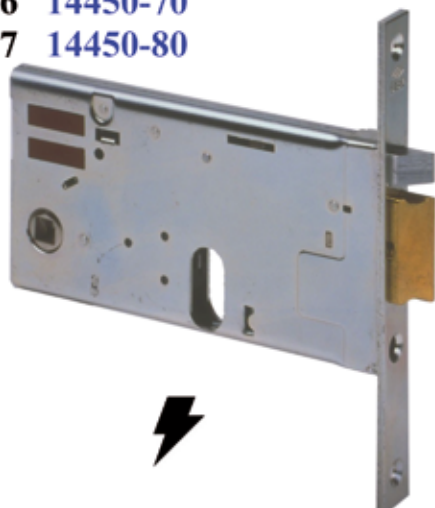

ALTEZZA SCATOLA MM. 77

**SERRATURA INFILARE
CILINDRO OVALE
SOLO MANDATE
ART.44210**

180083 44210-16



**SERRATURA INFILARE
CILINDRO OVALE
SOLO SCROCCO REVERS.
ART.44217**

180084 44217-15

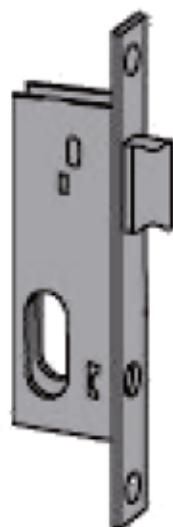

**SERRATURA INFILARE
SOLO FORO MANIGLIA
SCROCCO REVERS.
ART.44227**

180430 44227-15



**SERRATURA INFILARE
RULLO REGOLABILE
ART.44237**

180431 44237-15

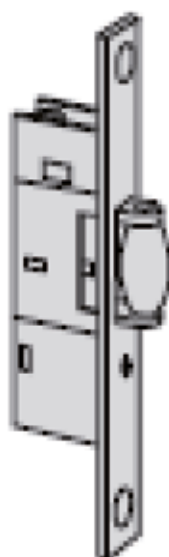

**SERRATURA INFILARE
CILINDRO SAGOMATO
CON GANCIO
ART.45110**

180432 45110-30

180433 45110-35

180434 45110-40

180435 45110-45

180436 45110-50

180437 45110-60



**SERRATURA ELETTRICA
INFILARE CILINDRO SAGOMATO
SCROCCO E MANDATA
ART. 19225**

180440 19225-25

180441 19225-30

180442 19225-35

180443 19225-40



**SERRATURA INFILARE
CILINDRO SAGOMATO
SCROCCO E MANDATA
ART. 49225**

180446 49225-25

180447 49225-30

180448 49225-35

180449 49225-40



**RULLO ACCESSORIO
PER SERRATURE SERIE 49000
ART. 06000000**

180450 REGOLABILE

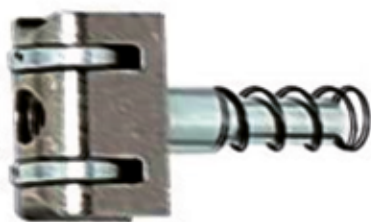

**SERRATURA INFILARE
CILINDRO SAGOMATO
TRIPLICE
ART.56357**

180085 56357-90

180086 56357-10



ALTEZZA SCATOLA MM. 64

**SERRATURA INFILARE
ELETTRICA DOPPIA MAPPA
CON MANDATA E SCROCCO
REG.12-18
ART.17352**

180089 17352-10



ALTEZZA SCATOLA MM. 78

**SERRATURA INFILARE
ELETTRICA DOPPIA MAPPA
TRIPLICE
CON MANDATA E SCROCCO
REG.12-18
ART.17357**

180090 17357-10



ALTEZZA SCATOLA MM. 78

**SERRATURA INFILARE
DOPPIA MAPPA
CON MANDATA E SCROCCO
REG.11/17
ART. 57352**

180087 57352-10



ALTEZZA SCATOLA MM. 78

**SERRATURA INFILARE
DOPPIA MAPPA
TRIPLICE
CON MANDATA E SCROCCO
REG.11/17
ART. 57357**

180088 57357-10



ALTEZZA SCATOLA MM. 78

**SERRATURA INFILARE
ELETTRICA DOPPIA MAPPA
CON MANDATA E SCROCCO
REG.11/17
ART.17359**

180070 17353-90

 **CISA**

**SERRATURA INFILARE
CILINDRO SAGOMATO
ART.5C611**

- 180150** MM. 40 OTT.
- 180151** MM. 40 BRO.
- 180152** MM. 45 OTT.
- 180153** MM. 45 BRO.
- 180154** MM. 50 OTT.
- 180155** MM. 50 BRO.
- 180156** MM. 60 OTT.
- 180157** MM. 60 BRO.



**SERRATURA INFILARE
ELETTRICA
CILINDRO SAGOMATO
ART. 12011**

- 180091** 12011-40
- 180092** 12011-50
- 180093** 12011-60
- 180094** 12011-70



**SERRATURA INFILARE
CILINDRO SAGOMATO
CATENACCIO E SCROCCO
4 MANDATE
ART. 56250**

- 180130** 56250-60



**SERRATURA INFILARE
CILINDRO SAGOMATO
CATENACCIO E SCROCCO
4 MANDATE
TRIPLICE
ART. 56255**

- 180131** ART.56255-60





**SERRATURA INFILARE
CILINDRO SAGOMATO
TRIPLICE
CATENACCIA A PISTONE
ART. 52526**

180105 52526-45
180106 52526-50
180107 52526-60



**SERRATURA INFILARE
DOPPIA MAPPA
4 MANDATE
SCROCCO E CATENACCIO
ART.57250**

180143 57250-60



**SERRATURA INFILARE
DOPPIA MAPPA
TRIPLICE
4 MANDATE
SCROCCO E CATENACCIO
ART.57255**

180148 57255-60



**SERRATURA INFILARE
DOPPIA MAPPA
2 MANDATE
SCROCCO E CATENACCIO
ART.57211**

180135 57211-45
180136 57211-50
180137 57211-60



**SERRATURA INFILARE
DOPPIA MAPPA
TRIPLICE
2 MANDATE
SCROCCO E CATENACCIO
ART.57215**

180140 57215-45
180141 57215-50
180142 57215-60



**SERRATURA INFILARE
DOPPIA MAPPA
TRIPLICE
CATENACCIO A PISTONI
ART.57035**

180112 57035-60
180113 57035-70



ALTEZZA SCATOLA MM. 82

**SERRATURA DA APPLICARE
DOPPIA MAPPA TRIPLICE
ART.57125**

180220 57125-60-1
180221 57125-60-2



**SERRATURA DA APPLICARE
DOPPIA MAPPA QUINTUPLICE
COMPLETA DI DEVIATORE
ART.57135**

180222 57135-60-1
180223 57135-60-2

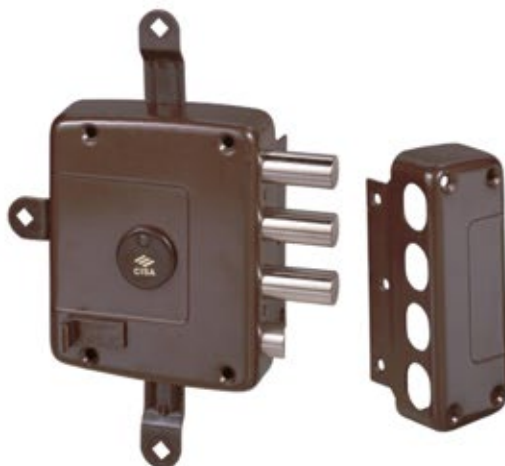

**SERRATURA DA APPLICARE
A CILINDRO SAGOMATO
TRIPLICE
ART. 56167**

180501 56167-60-1
180502 56167-60-2



**SERRATURA DA APPLICARE
A CILINDRO SAGOMATO
QUINTUPLICE
ART. 56177**

180503 56177-60-1
182504 56177-60-2



**FERROGLIETTO
DA APPLICARE
CON CILINDRO STACCATO
ART.55071**

180095 55071-50-1
180096 55071-60-1



**ASTE PER SERRATURE
SERIE 56-57**

180225 TRIPLICE
180227 QUINTUPLICE



**SERRATURA DOPPIA MAPPA
INFILARE TRIPLICE
CON CHIAVE DI SERVIZIO
DIMENSIONI CISA
ART. 57535-48-0**

180510 INTERASSE MM. 28

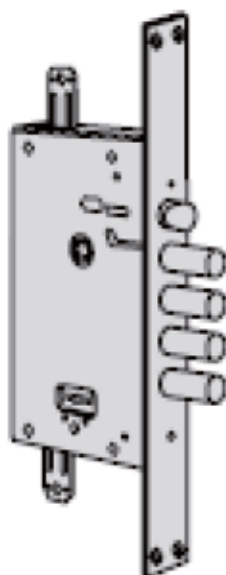

**SERRATURA DOPPIA MAPPA
AD APPLICARE TRIPLICE
CON CHIAVE DI SERVIZIO
DIMENSIONI MOTTURA
ART. B 7515-48-0**

180511 INTERASSE MM. 28

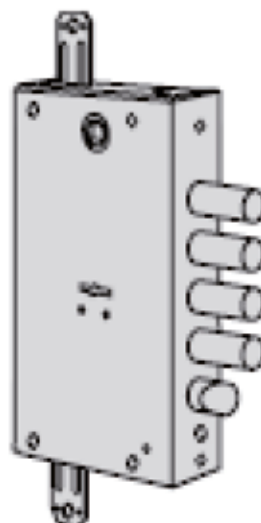

**SERRATURA DOPPIA MAPPA
INFILARE TRIPLICE
DIMENSIONI MOTTURA
ART. B 7535-48-0**

180512 INTERASSE MM. 28

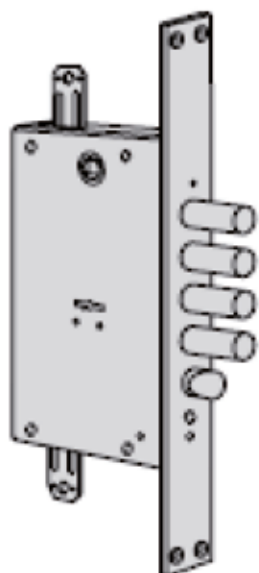

**SERRATURA DOPPIA MAPPA
INFILARE TRIPLICE
DIMENSIONI MOTTURA
ART. B 7535-58-0**

180513 INTERASSE MM. 38

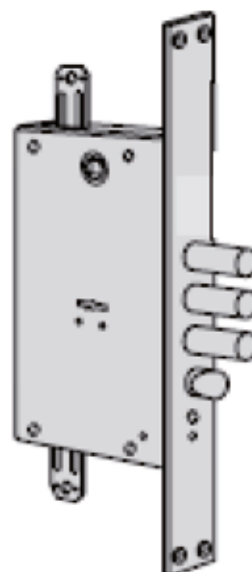

**SERRATURA AD APPLICARE
TRIPLICE
CON PRED. CIL. EUROPEO
CON TRAPPOLA (B)
DIMENSIONI CISA
ART. 56515-48 B**

180514 INTERASSE MM. 28

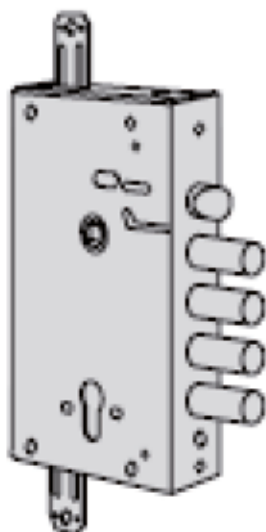

**SERRATURA AD APPLICARE
TRIPLICE
CON PRED. CIL. EUROPEO
CON TRAPPOLA (B)
DIMENSIONI CISA
ART. 56515-58 B**

180515 INTERASSE MM. 38

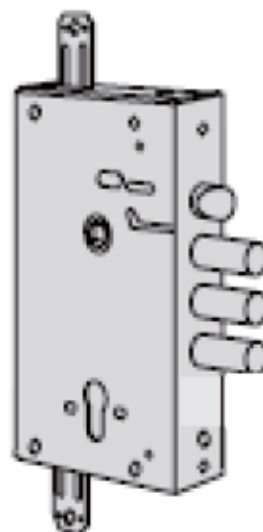

**SERRATURA AD APPLICARE
TRIPLICE
DOPPIA MAPPA
DIMENSIONI CISA
ART. 57515-48**

180516 INTERASSE MM. 28

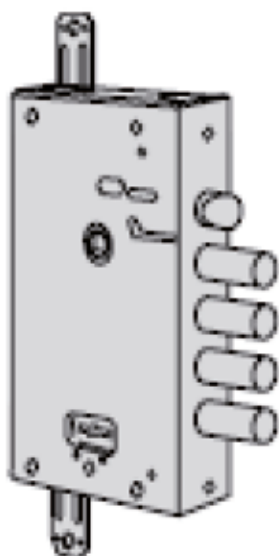

**SERRATURA AD APPLICARE
TRIPLICE
DOPPIA MAPPA
DIMENSIONI CISA
ART. B7515-58**

180517 INTERASSE MM. 38

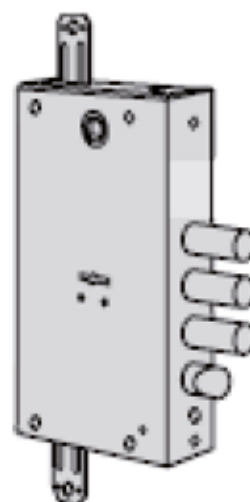

**SERRATURA AD APPLICARE
TRIPLICE
CON PRED. CIL. EUROPEO
CON TRAPPOLA (B)
DIMENSIONI MOTTURA
ART. B6515-48 B**

180518 INTERASSE MM. 28

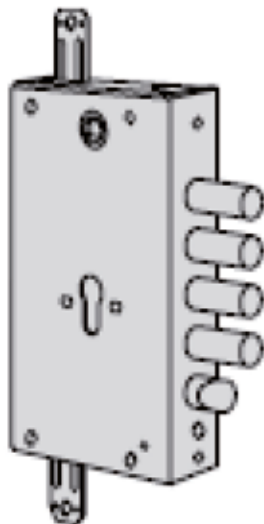

**SERRATURA AD APPLICARE
TRIPLICE
CON PRED. CIL. EUROPEO
CON TRAPPOLA (B)
DIMENSIONI MOTTURA
ART. B6515-38-B**

180519 INTERASSE MM. 38

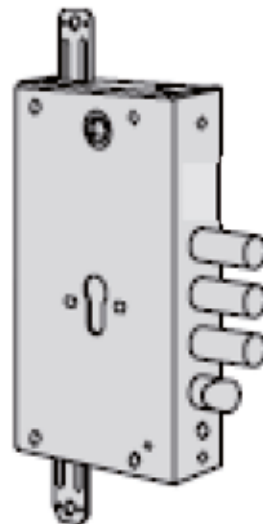

**SERRATURA INFILARE
TRIPLICE
CON PRED.CIL. EUROPEO
CON TRAPPOLA (B)
DIMENSIONI MOTTURA
ART. B6535-48 B**

180520 INTERASSE MM. 28



**SERRATURA AD APPLICARE
TRIPLICE
CON PRED. CIL. EUROPEO
CON TRAPPOLA (B)
DIMENSIONI DIERRE
ART. B6515-48 B 00DH**

180521 INTERASSE MM. 28

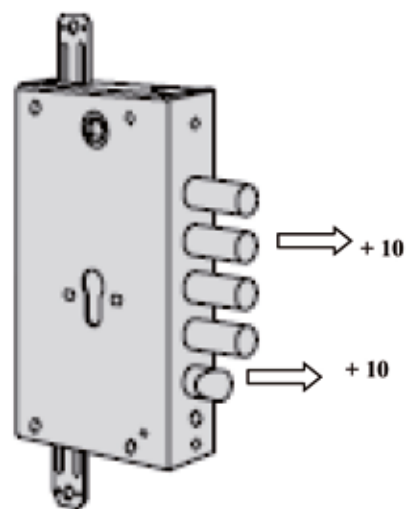

CHIUDIPIORTA SMART PLUS 2
SENZA FERMO
PER PORTE MAX CM 95
FORZA 2-3
ART. C1415030

180170 C1415030-97 ARGENTO

180171 C1415030-44 NERO



CHIUDIPIORTA SMART PLUS 2
CON FERMO
PER PORTE MAX CM 95
FORZA 2-3
ART. C1416030

180172 C1416030-97 ARGENTO

180173 C1416030-44 NERO



CHIUDIPIORTA
PROFESSIONAL PLUS 2
SENZA FERMO
PER PORTE FINO A CM. 110
FORZA 2-4
ART. C1510030

180522 C1510030-97 ARGENTO

180523 C1510030-44 NERO



CHIUDIPIORTA
PROFESSIONAL PLUS 2
CON FERMO
PER PORTE FINO A CM. 110
FORZA 2-4
ART. C1511030

180524 C1511030-97 ARGENTO

180525 C1511030-44 NERO



**CHIUDIPIORTA
PROFESSIONAL PLUS 2
SENZA FERMO
PER PORTE FINO A CM. 126
FORZA 2-6
ART. C1610050**

180526 C1610050-97 ARGENTO

180527 C1610050-44 NERO



**CHIUDIPIORTA
PROFESSIONAL PLUS 2
CON FERMO
PER PORTE FINO A CM. 126
FORZA 2-6
ART. C1611050**

180528 C1611050-97 ARGENTO

180529 C1611050-44 NERO



**CHIUDIPIORTA COLORE ORO
SENZA FERMO
ART. 601/T**

180530 6013001098 MAX CM. 75
180531 6014002098 MAX CM. 83
180532 6015003098 MAX CM. 93
180533 6016004098 MAX CM. 103



**CHIUDIPIORTA SERIE 601/T
CON FERMO
ART.601/T**

180534 6013101098 MAX CM. 75
180535 6014102098 MAX CM. 83
180536 6015103098 MAX CM. 93
180537 6016104098 MAX CM. 103



CARDINE CHIUDIPIORTA
ART. C1310

180538 C 1310010 NERO



MANIGLIONI ANTIPANICO
FAST PUSH
ART. 59011-10-0

180180 NERO



MANIGLIONI ANTIPANICO
FAST TOUCH
ART. 59811-10-0

180181 CM. 120



CHIUSURE PER ANTIPANICO
ART. 07063-61-0

180182 ALTO BASSO



BARRA PER MANIGLIONI
ART. 07007-14-0

180183 CM 120 ROSSA



MANIGLIA PER ANTIPANICO
ART. 07078.38.0.00

180184 CON CILINDRO NERA



INCONTRO ELETTRICO
PER MANIGLIONI ANTIPANICO
ART. 07083-15

180539 S/ANTIRIPETITORE



INCONTRO ELETTRICO
PER SERRATURE INFILARE
ART. 15001-00

180100 AMBIDESTRO



**CILINDRO A SPILLO
PER SERRATURE
SERIE 1600-46000
ART. 02400 10**

180328 CON ADATTATORE



**BOBINA
PER SERRATURA ELETTRICA
SERIE : 1A721-1A731
ART. 7025**

180050 TENSIONE 12 V



**BOBINA
PER SERRATURA ELETTRICA
SERIE:11721-11731-11761
11771-11921-
ART. 07118-00**

180051 07118-01 DESTRA

180052 07118-02 SINISTRA



**BOBINA REGOLABILE
PER SERRATURA ELETTRICA
SERIE:11721-11731-11761
11771-11921
ART. 07120-00**

180540 07120-01 DESTRA

180541 07120-02 SINISTRA



**GORGES DI RICAMBIO
PER SERRATURE DOPPIA MAPPA**

SERIE:

57115-1 / 57125-1 / 57135-1 (DESTRE)

E PER :

57500 57502 57505 57507 57510 57512

57515 57517 57250 57525 57530 57535

ART. 07590

180542 07590-25-0

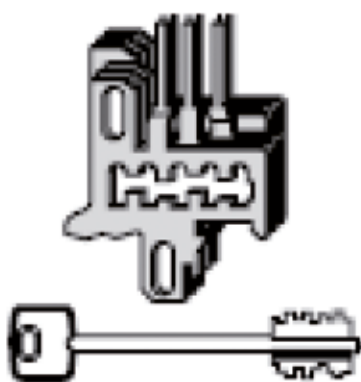

**GORGES DI RICAMBIO
PER SERRATURE DOPPIA MAPPA**

SERIE:

57115-2 / 57125-2 / 57135-2 (SINISTRE)

ART. 07590

180543 07590-28-0



**CHIAVI DI CAMBIO
PER SERRATURA DOPPIA MAPPA**

RICIFRABILE

CHIAVE CORTA

CON 3 CHIAVI +1 DI CAMBIO

ART. 06520-00-1

180544 CAMBIO FACILE



**CHIAVI DI CAMBIO
PER SERRATURA DOPPIA MAPPA**

RICIFRABILE

CHIAVE CORTA

CON 3 CHIAVI + 1 ATTREZZO DI

CAMBIO

ART. 06520-50-1

180545 NEW CAMBIO FACILE





CISA[®]

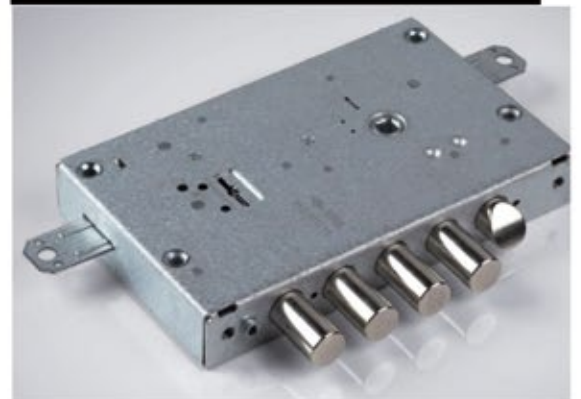

AR

SERRATURE





Sistema brevettato MRX Plus®

MRX PLUS® integra nella chiave un inserto magnetico ed un elemento sferico mobile che vengono letti e decodificati dalla serratura.

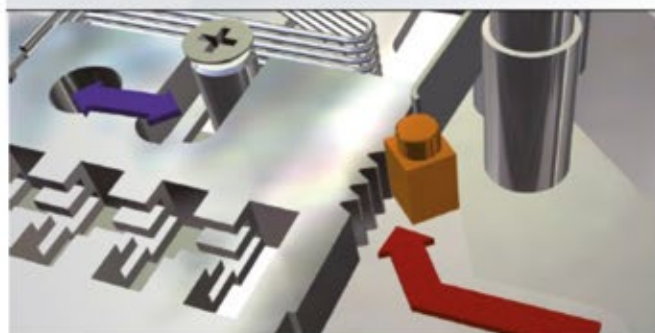

DM Plus®

DM PLUS® è un innovativo sistema di protezione delle serrature a doppia mappa e rappresenta una vera barriera antintrusione.

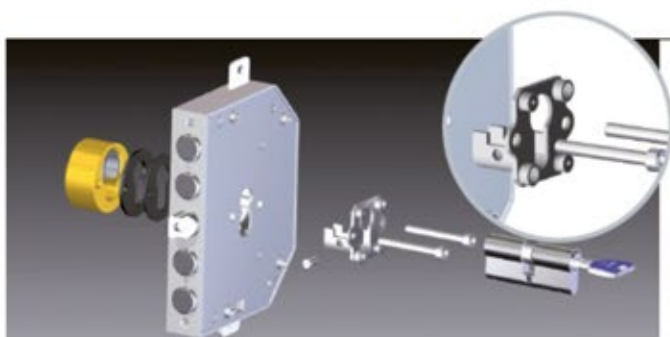

PE New

SIMPLY® nuovo e agevole sistema di fissaggio del cilindro e della corazza di protezione.

PE NEW

www.dom-cr.it

we **dom**ore for security



**CILINDRI CR
K 55
CON CHIAVE PUNZONATA
DIAM. MM 29 POMPA MM. 60**

104305 PER CR



**CILINDRI CR
K 55
CON CHIAVE PUNZONATA
DIAM. MM 29 POMPA MM. 60**

104307 PER CERUTTI



**CILINDRI CR
K 55 M
CON CHIAVE PUNZONATA
DIAM. 34 POMPA MM. 60**

104306 PER MOTT



**SERRATURA CR
TRIPLICE DOPPIA MAPPA
CON SCROCCO
ART.2251**

**104300 MM. 28 DX
104301 MM. 28 SX**



**SERRATURA CR
TRIPLICE DOPPIA MAPPA
ART.2201**

**104302 MM.28 DX
104303 MM.28 SX**

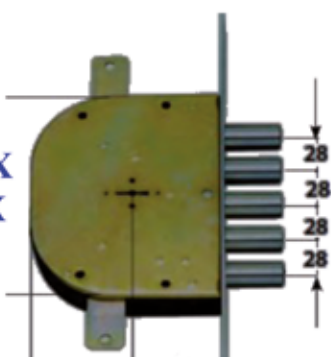

**SERRATURA CR
TRIPLICE PER CIL. EUROPEO
REVERSIBILE**

104304 ART. 2151

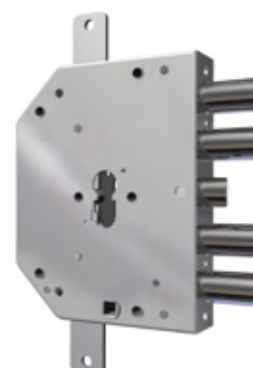



SA.ME. FERRAMENTA s.n.c.

di Saraceno Gabriele & C.

95123-Catania-Viale Montenero,34

Tel. 095-350829 Fax 095-350829



samefer@tiscali.it



www.sameferramenta.com





**DEFENDER SFERIK
ANTISTRAPPO DIAM. MM 50
INTERASSE MM.38
SPESSORE MM. 25
ART. BDS16D1P
PER: MOTTURA -CISA-SAB
CERUTTI -FIAM-SECUREMME**

- 191000 OTTONE LUCIDO**
- 191001 CROMO SATINATO**
- 191002 BRONZATO**

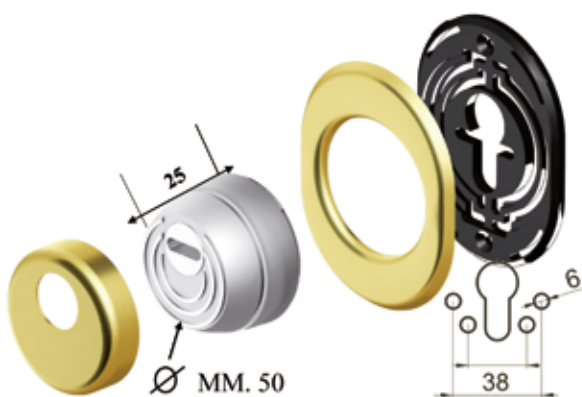

**DEFENDER SFERIK
ANTISTRAPPO DIAM. MM. 50
INTERASSE MM. 31
SPESSORE MM. 25
ART. BDS68D1P
PER: ATRA**

- 191003 OTTONE LUCIDO**
- 191004 CROMO SATINATO**
- 191005 BRONZATO**

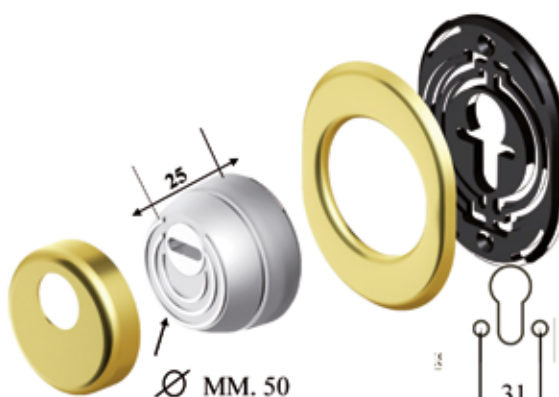

**DEFENDER MONOLITO ROK
ANTISTRAPPO DIAM. MM. 50
INTERASSE MM. 38
SPESSORE MM. 18
ART. BD201-20D1
PER: MOTTURA-CISA-SAB
CERUTTI-FIAM-SECUREMME**

- 191018 OTTONE LUCIDO**
- 191019 CROMO SATINATO**
- 191020 BRONZATO**

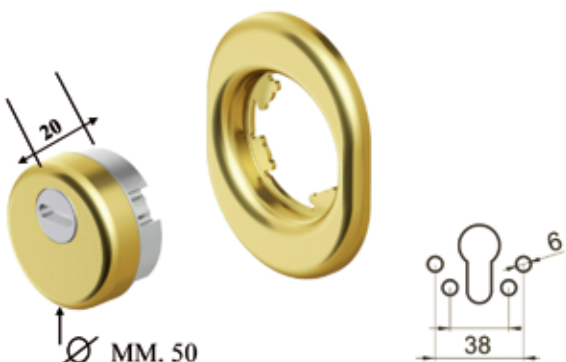

**DEFENDER MONOLITO ROK
ANTISTRAPPO DIAM. MM. 50
INTERASSE MM. 38
SPESSORE MM. 25
ART. BD201-25D1
PER: MOTTURA-CISA-SAB
CERUTTI-FIAM-SECUREMME**

- 191006 OTTONE LUCIDO**
- 191007 CROMO SATINATO**
- 191008 BRONZATO**

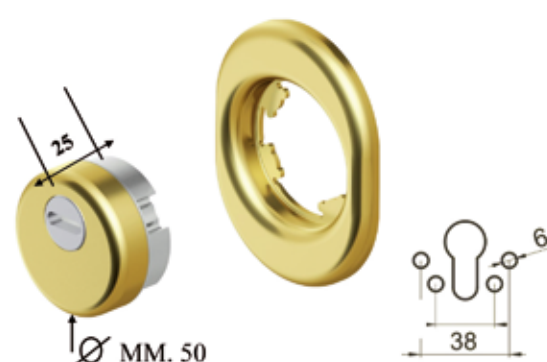

**DEFENDER MONOLITO ROK
ANTISTRAPPO DIAM. MM. 50
INTERASSE MM. 31
SPESSORE MM. 25
ART. BD301-25D1
PER: ATRA**

- 191023 OTTONE LUCIDO**
- 191024 CROMO SATINATO**
- 191025 BRONZATO**

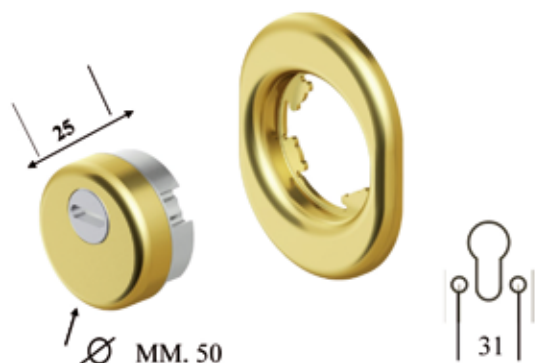

**DEFENDER MAGNETICO
MINIMAG MM. 40X118
CON 2 CHIAVI MAGNETICHE
ART. MG110-3W
PER CILINDRO SAGOMATO**

- 191009 OTTONE LUCIDO**
- 191010 CROMO SATINATO**
- 191021 BRONZATO**



**DEFENDER MAGNETICO
MINIMAG MM. 55X118
CON 2 CHIAVI MAGNETICHE
ART. MG220-4W
PER DOPPIA MAPPA**

- 191011 OTTONE LUCIDO**
- 191012 CROMO SATINATO**
- 191022 BRONZATO**



**DEFENDER MAGNETICO
MINIMAG MM. 55X108
CON 2 CHIAVI MAGNETICHE
ART. MG410-4W
PER DOPPIA MAPPA -POMPA**

- 191014 OTTONE LUCIDO**
- 191015 CROMO SATINATO**
- 191016 BRONZATO**



**MOSTRINA DI RICAMBIO
PER SERRATURE ATRA
MM. 80X98
ART. A1608**

191026 OTTONE LUCIDO
191027 BRONZATO



**MOSTRINA PER DEFENDER
COMPLETA DI SUPPORTO
MM. 65X85 FORO MM. 50.5
ART. KT056**

191028 OTTONE LUCIDO
191029 CROMO SATINATO
191030 BRONZATO



**SPESSORI PER DEFENDER
SFERIK- MONOLITO ROK
DIAMETRO MM. 50 UNIVERSALE
ZINCATO**

191031 ART. 1565 MM. 1
191032 ART. 1566 MM. 2.5



**PLACCA DI ANCORAGGIO
PER DEFENDER
MAGNETICO MG 220
ART. A2748
ZINCATO**

191013 MM. 60X130

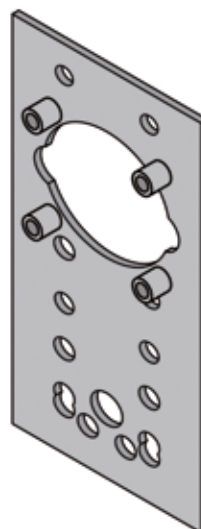

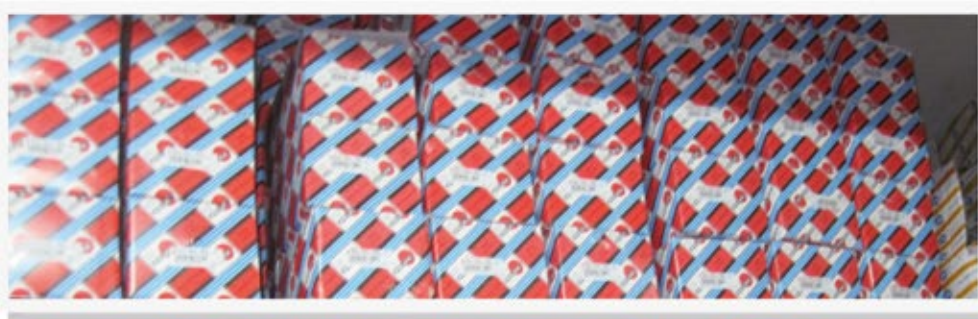

SA.ME. FERRAMENTA s.n.c.
di Saraceno Gabriele & C.



F.lli Facchinetti s.r.l.





**SERRATURA PORTONCINO
CILINDRO FISSO
2-3 MANDATE**

- 108000 MM. 50DX**
- 108001 MM. 50SX**
- 108002 MM. 60 DX**
- 108003 MM. 60 SX**
- 108004 MM. 70 DX**
- 108005 MM. 70 SX**



**SERRATURA PORTONCINO
CILINDRO FISSO 3 MANDATE
CON FORO MANIGLIA
ZINCATA**

- 108006 MM.60 DX**
- 108007 MM.60 SX**
- 108008 MM.70 DX**
- 108009 MM.70 SX**



**SERRATURA ELETTRICA
SOLO SCROCCO
ZINCATA**

- 108020 MM. 60 DX**
- 108021 MM. 60 SX**
- 108022 MM. 70 DX**
- 108023 MM. 70 SX**



**SERRATURA ELETTRICA
SCROCCO E MANDATE
ZINCATA**

- 108024 MM. 60 DX**
- 108025 MM. 60 SX**
- 108026 MM. 70 DX**
- 108027 MM. 70 SX**



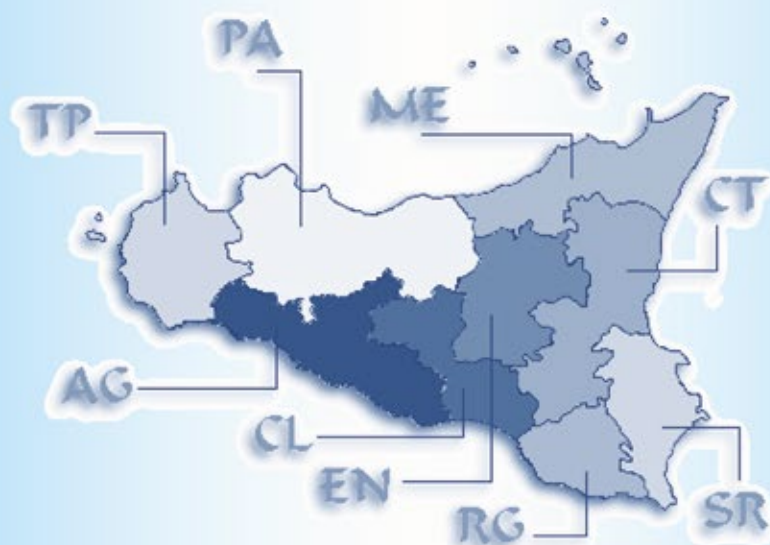

 **TASSELLI-VITERIE** 

 **IDRAULICA**

MINUTERIA METALLICA 

 **COLORI**

FERRAMENTA 

 **CASALINGHI**



WWW.SAMEFERRAMENTA.COM

ISEO[®]

FIAM.[®]



ISEO SERRATURE S.p.A.



ISEO
Serrature
Serrature

An ISEO HOLDING company

ISEO
la potenza della sicurezza



**SERRATURA INFILARE
A CHIODO
4 MANDATE
ART. 1300K**

- 104550** ENT. MM. 40
- 104551** ENT. MM. 50
- 104552** ENT. MM. 60
- 104553** ENT. MM. 70



**SERRATURA INFILARE
A CHIODO
4 MANDATE E SCROCCO
ART. 1320K**

- 104560** ENT. MM. 50
- 104561** ENT. MM. 60
- 104562** ENT. MM. 70



**SERRATURA INFILARE
A CHIODO
1 MANDATA
ART. 1500K**

- 104565** ENT. MM. 40
- 104566** ENT. MM. 50
- 104567** ENT. MM. 60



**SERRATURA INFILARE
PER PROFILATI
A CHIODO
1 MANDATA
ART. 903K**

- 104568** ENT. MM. 16





**SERRATURA INFILARE
PER PROFILATI
A CHIODO
1 MANDATA E SCROCCO
ART. 901K**

104555 ENTRATA MM. 16



**SERRATURA INFILARE
PER PROFILATI
A CHIODO
1 MANDATA E RULLO
ART. 902K**

104556 ENTRATA MM. 16



**SERRATURA INFILARE
PER CANCELLI SCORREVOLI
ELETTRICA A GANCIO
ART. 381 EGI**

104575 ENTRATA MM. 90



**SERRATURA AD APPLICARE
PER CANCELLI SCORREVOLI
ELETTRICA A GANCIO
ART. 380 EGR**

104576 ENTRATA MM. 90 DX

104577 ENTRATA MM. 90 SX

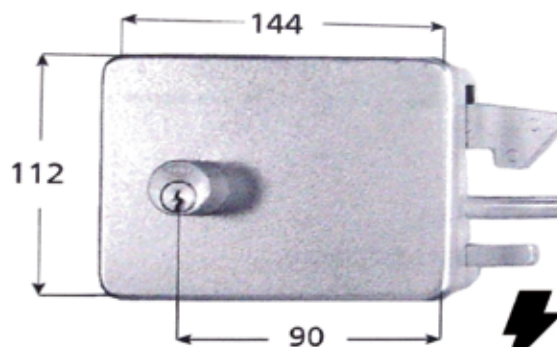



**SERRATURA ELETTRICA
SOLO SCROCCO**
ART. 5250

104200 MM. 50 DX
104201 MM. 50 SX
104202 MM. 60 DX
104203 MM. 60 SX
104204 MM. 70 DX
104205 MM. 70 SX
104206 MM. 80 DX
104207 MM. 80 SX



**SERRATURA ELETTRICA
SCROCCO E PULSANTE**
ART. 5253

104210 MM. 50 DX
104211 MM. 50 SX
104212 MM. 60 DX
104213 MM. 60 SX
104214 MM. 70 DX
104215 MM. 70 SX
104216 MM. 80 DX
104217 MM. 80SX



**SERRATURA ELETTRICA
SCROCCO E MANDATE**
ART. 5350

104220 MM. 50 DX
104221 MM. 50 SX
104222 MM. 60 DX
104223 MM. 60 SX
104224 MM. 70 DX
104225 MM. 70 SX
104226 MM. 80 DX
104227 MM. 80 SX



**SERRATURA ELETTRICA
MANDATE E PULSANTE**
ART. 5352

104230 MM. 50 DX
104231 MM. 50 SX
104232 MM. 60 DX
104233 MM. 60 SX
104234 MM. 70 DX
104235 MM. 70 SX
104236 MM. 80 DX
104237 MM. 80 SX



**SERRATURA ELETTRICA
REVERSIBILE
ZINCATA
ART. 505**

104245 ART. 505604 MM. 60

104246 ART. 505704 MM. 70



**COPPIA BOBINE
PER ELETTROSERRATURA
ART. 5250-5253-5350-5352**

104240 ART. 050035



**SERRATURA PORTONCINO
AD APPLICARE 2-3 MANDATE
ART. 431/2**

103091 431 MM. 50 DX

103095 432 MM. 50 SX

103092 431 MM. 60 DX

103096 432 MM. 60 SX

103093 431 MM. 70 DX

103097 432 MM. 70 SX



**SERRATURA PORTONCINO
AD APPLICARE 3 MANDATE
CON FORO MANIGLIA
ART. 481/2**

103098 481 MM. 60 DX

103099 482 MM. 60 SX





**SERRATURA A POMPA
TRIPLICE
CON POMPA MM. 60
ART. 913105**

104282 DESTRA
104283 SINISTRA

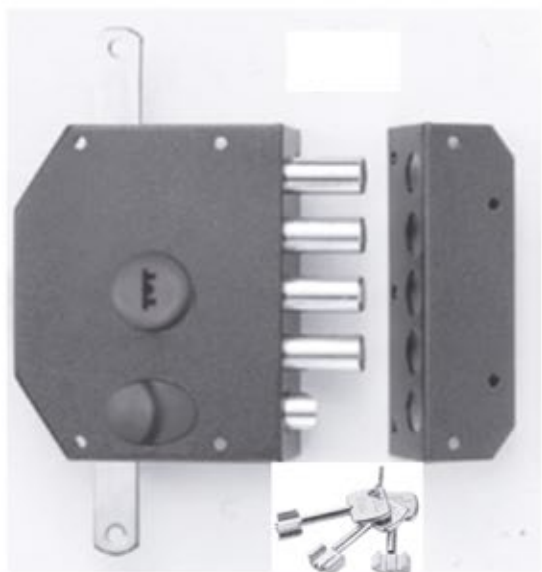

**POMPA DI RICAMBIO
SERRATURA PERFECTA
ART. 9900**

104294 990011 MM. 50
104284 990012 MM. 60



**FERROGLIETTO
CILINDRO FISSO
GIRI 5 + SCROCCO
ART. 315
CONF. INDUSTRIALE**

103115 MM. 50
103116 MM. 60



**FERROGLIETTO
CILINDRO FISSO
GIRI 6
ART. 315
CONF. INDUSTRIALE**

103113 MM. 50
103114 MM. 60





**SERRATURA INFILARE
CON MANDATE
COMPLETA DI CILINDRO
ART. 704**

104272 7046010 MM. 60
104273 7047010 MM. 70
104274 7047010 MM. 80



**SERRATURA ELETTRICA
INFILARE
C/SCROCCO E PISTONE
SEPARATO
ART. 550**

104270 5506010 MM. 60
104271 5507010 MM. 70

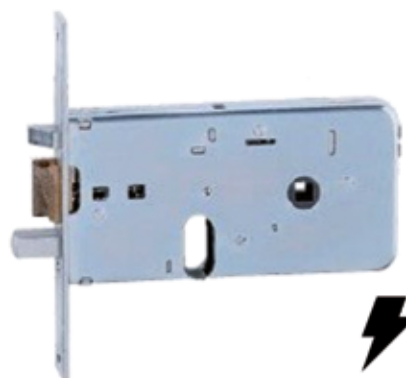

**SERRATURA INFILARE
C/MANDATA E SCROCCO
FRONTALE MM. 16
COMPLETA DI CILINDRO
ART. 750151**

104259 750151



**SERRATURA INFILARE
C/MANDATA E RULLO
FRONTALE MM. 16
COMPLETA DI CILINDRO
ART. 752151**

104260 752151



**SERRATURA INFILARE
SOLO MANDATA
FRONTALE MM. 16
COMPLETA DI CILINDRO
ART. 760151**

104261 760151



**SERRATURA INFILARE
SOLO RULLO
FRONTALE MM. 16
ART. 764001**

104263 764001



**SERRATURA INFILARE
C/GANCIO
FRONTALE 16
COMPLETA DI CILINDRO
ART. 7682010**

104264 7682010



**SERRATURA INFILARE
SOLO SCROCCO
FRONTALE MM. 16
ART. 762001**

104262 762001





**SERRATURA ELETTRICA
INFILARE TRIPLICE
AD AVANZAMENTO MECCANICO
FRONTALE INOX MM. 22
ART. 729514-28**

- 104430 MM. 25
- 104431 MM. 30
- 104432 MM. 35
- 104433 MM. 40



**SERRATURA INFILARE
TRIPLICE
AD AVANZAMENTO MECCANICO
FRONTALE INOX MM. 22
ART.727514-22**

- 104434 MM. 25
- 104435 MM. 30
- 104436 MM. 35
- 104437 MM. 40



**SERRATURA INFILARE
TRIPLICE
SOLO CATENACCIO
BASCULANTE
FRONTALE ZINCATO MM. 24
ART. 783-3IFZ**

- 104438 MM. 25
- 104439 MM. 30
- 104440 MM. 35



**SERRATURA INFILARE
TRIPLICE
CON SCROCCO
E CATENACCIO BASCULANTE
FRONTALE ZINCATO MM. 24
ART. 783-1IFZ**

- 104441 MM. 25
- 104442 MM. 30
- 104443 MM. 35





**SERRATURA ELETTRICA
INFILARE TRIPLICE
CON SCROCCO
E CATENACCIO BASCULANTE
FRONTALE INOX MM. 22
ART. 783802-2**

104250 MM. 25
104251 MM. 30
104252 MM. 35



**SERRATURA
INFILARE TRIPLICE
CON SCROCCO
E CATENACCIO BASCULANTE
FRONTALE INOX MM. 22
ART. 783102-2**

104253 MM. 25
104254 MM. 30
104255 MM. 35



**SERRATURA
INFILARE TRIPLICE C/RULLO
E CATENACCIO BASCULANTE
FRONTALE INOX MM. 22
ART. 783202-2**

104256 MM. 25
104257 MM. 30
104258 MM. 35



**CONTROPIASTRE
REGOLABILI
ACCIAIO VERNICIATO NERO**

103110 ART. 0386011
X SERIE 78
MM. 229X21
FIG. 1

103112 ART. 038631
X SERIE 72
MM. 240X21
FIG. 2



**SERRATURA INFILARE
DOPPIA MAPPA
FRONTALE MM. 25
ART. 661-4N**

104275 ENTRATA MM. 52
104276 ENTRATA MM. 60
104277 ENTRATA MM. 70



**SERRATURA INFILARE
DOPPIA MAPPA TRIPLICE
FRONTALE MM. 25
ART. 663301-4**

104279 ENTRATA MM. 60
104280 ENTRATA MM. 70



**SERRATURA INFILARE
DOPPIA MAPPA
FRONTALE INOX MM. 22
ALTEZZA CASSA MM. 64
ART. 961110902**

104266 ENTRATA MM. 90



**SERRATURA INFILARE
DOPPIA MAPPA TRIPLICE
FRONTALE INOX MM. 22
ALTEZZA CASSA MM. 64
ART. 963110902**

104295 ENTRATA MM. 90





**SERRATURA INFILARE
DOPPIA MAPPA
FRONTALE MM. 25
ALTEZZA CASSA MM. 82
ART. 981901BFZ**

104267 ENTRATA MM. 90



**SERRATURA INFILARE
DOPPIA MAPPA TRIPLICE
FRONTALE MM. 25
ALTEZZA CASSA MM. 82
ART. 983901BFZ**

104268 ENTRATA MM. 90



**SERRATURA INFILARE
DOPPIA MAPPA
FRONTALE MM. 24
ALTEZZA CASSA MM. 64
ART. 961901B4**

104269 ENTRATA MM. 90



**SERRATURA INFILARE
DOPPIA MAPPA TRIPLICE
FRONTALE MM. 24
ALTEZZA CASSA MM. 64
ART. 963901B4**

104770 ENTRATA MM. 90





**SERRATURA INFILARE
DOPPIA MAPPA ELETTRICA
FRONTALE INOX MM. 22
ALTEZZA CASSA MM. 64
ART. 961910902**

104265 ENTRATA MM. 90

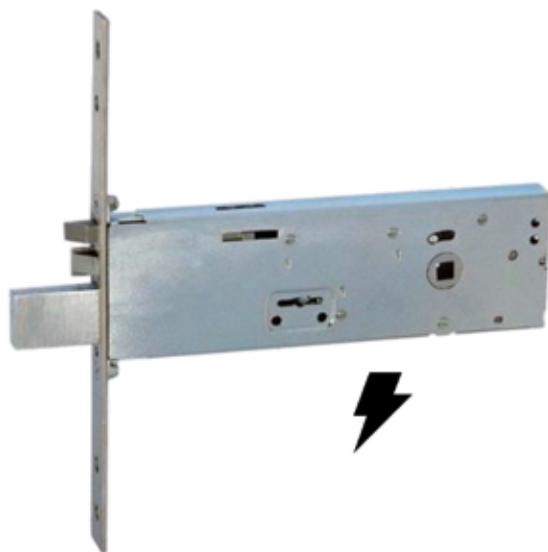

**SERRATURA INFILARE TRIPLICE
DOPPIA MAPPA ELETTRICA
FRONTALE INOX MM. 22
ALTEZZA CASSA MM. 64
ART. 963910902**

104771 ENTRATA MM. 90



**SERRATURA INFILARE TRIPLICE
A CILINDRO SAGOMATO
SCROCCO REVERSIBILE
FRONTALE INOX MM. 24
ALTEZZA CASSA MM. 64
ART. 963120902**

104772 ENTRATA MM. 90



**SERRATURA INFILARE TRIPLICE
ELETTRICA
A CILINDRO SAGOMATO
SCROCCO REVERSIBILE
FRONTALE INOX MM. 24
ALTEZZA CASSA MM. 64
ART. 963920902**

104773 ENTRATA MM. 90

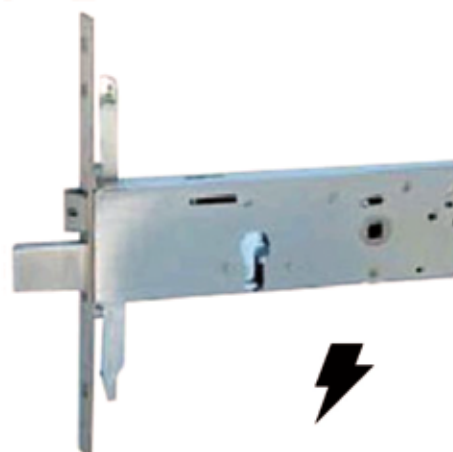



**CONTROPIASTRA
ACCIAIO ZINCATO**

104278 ART. 990817
MM. 240X25
ART. 661-663
FIG 1

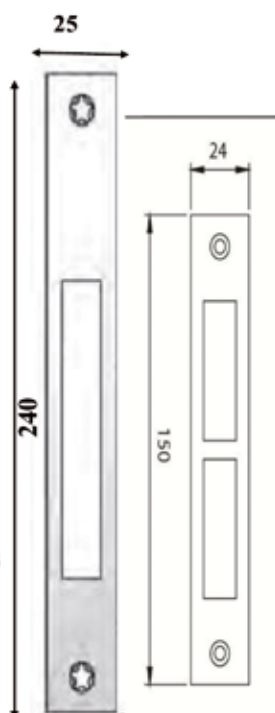

104774 ART. 038080
MM. 150X24
X ART. 981-983

**CONTROPIASTRA
REGOLABILE
ACCIAIO VERN. NERO**

104775 ART.0387011
MM. 199X21
X ART. 961-963
E PER SERIE 78



**SERRATURA DA INFILARE
DOPPIA MAPPA TRIPLICE
REVERSIBILE
CON 3 CHIAVI + 1 CANTIERE
ART.618.0028.01.05**

104776 INTERASSE MM. 28



**SERRATURA DA INFILARE
DOPPIA MAPPA TRIPLICE
REVERSIBILE
CON 3 CHIAVI + 1 CANTIERE
ART. 618.0037.01.05**

104777 INTERASSE MM. 37



**SERRATURA DA INFILARE
DOPPIA MAPPA TRIPLICE
REVERSIBILE
CON 3 CHIAVI + 1 CANTIERE
ART.618.0028.01.F5**

104778 INTERASSE MM. 28



**SERRATURA DA INFILARE
DOPPIA MAPPA TRIPLICE
REVERSIBILE
CON 3 CHIAVI + 1 CANTIERE
ART.618.00238.01.F5**

104779 INTERASSE MM. 38



**SERRATURA DA APPLICARE
DOPPIA MAPPA TRIPLICE
REVERSIBILE
CON 3 CHIAVI + 1 CANTIERE
ART. 608.0328.0105**

104780 INTERASSE MM. 28



**SERRATURA DA APPLICARE
DOPPIA MAPPA TRIPLICE
REVERSIBILE
CON 3 CHIAVI + 1 CANTIERE
ART. 608.0337.0105**

104781 INTERASSE MM. 37





**SERRATURA DA APPLICARE
DOPPIA MAPPA TRIPLICE
REVERSIBILE
CON 3 CHIAVI + 1 CANTIERE
SCROCCO AVANZATO CM. 1
ART. 608.1328.0105**

104782 INTERASSE MM. 28

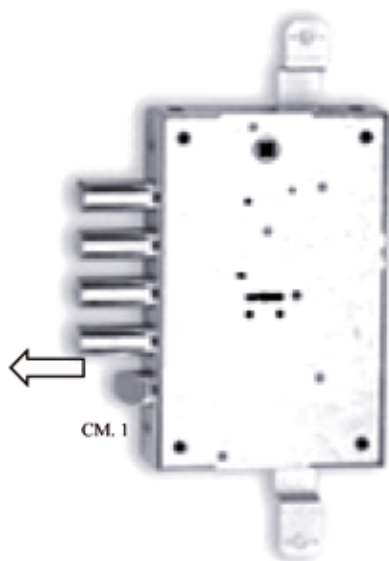

**SERRATURA DA APPLICARE
DOPPIA MAPPA TRIPLICE
REVERSIBILE
CON 3 CHIAVI + 1 CANTIERE
SCROCCO AVANZATO CM. 1
ART. 608.1337.0105**

104783 INTERASSE MM. 37

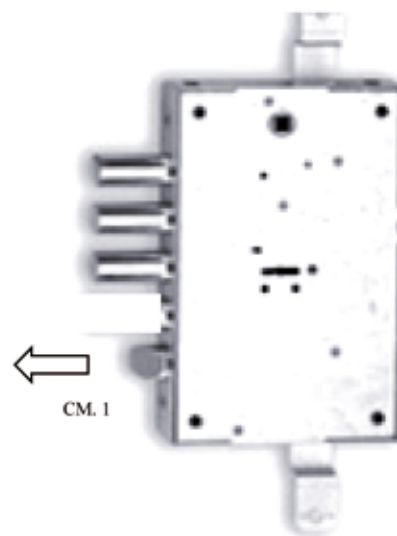

**SERRATURA DA APPLICARE
DOPPIA MAPPA TRIPLICE
REVERSIBILE
CON 3 CHIAVI + 1 CANTIERE
ART. 608.0328.01F5**

104784 INTERASSE MM. 28



**SERRATURA DA APPLICARE
DOPPIA MAPPA TRIPLICE
REVERSIBILE
CON 3 CHIAVI + 1 CANTIERE
ART. 608.0338.01F5**

104785 INTERASSE MM. 38



**SERRATURA DA APPLICARE
DOPPIA MAPPA TRIPLICE
REVERSIBILE
CON 3 CHIAVI + 1 CANTIERE
SCROCCO AVANZATO CM. 1
ART. 608.1328.01F5**

104786 INTERASSE MM. 28

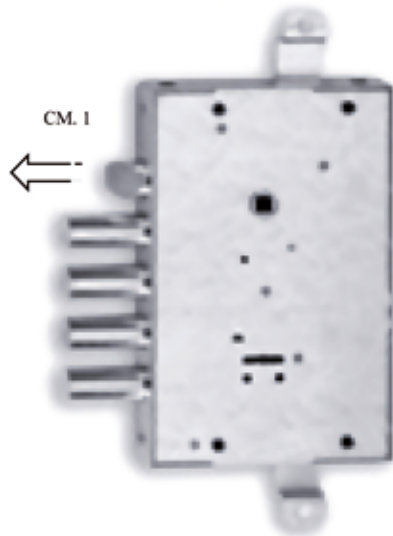

**SERRATURA DA APPLICARE
DOPPIA MAPPA TRIPLICE
REVERSIBILE
CON 3 CHIAVI + 1 CANTIERE
SCROCCO AVANZATO CM. 1
ART. 608.1338.01F5**

104787 INTERASSE MM. 38

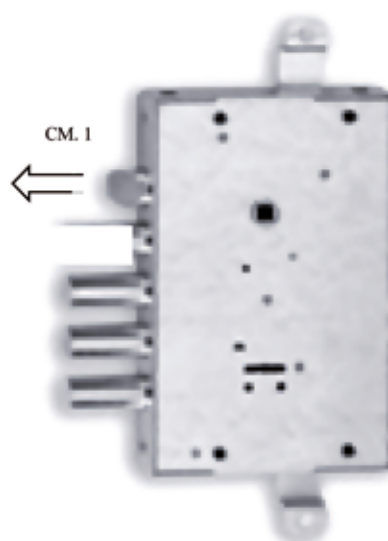

**SERRATURA DA APPLICARE
DOPPIA MAPPA TRIPLICE
REVERSIBILE
CON 3 CHIAVI
ART. 608.0537.0081**

104788 INTERASSE MM. 37



**CILINDRO A SPILLO
PRAZIS
PER SERRATURE:
1300K-1320K
1500K-903K
ART. 70.00.75**

103956 C/3 CHIAVI MM. 75



**SERRATURA AD INFILARE
CON PREDISPOSIZIONE
CILINDRO EUROPEO
TRIPLICE REVERSIBILE
ART. 678.0028.0G00**

104789 INTERASSE MM. 28



**SERRATURA AD INFILARE
CON PREDISPOSIZIONE
CILINDRO EUROPEO
TRIPLICE REVERSIBILE
ART. 678.0037.0G00**

104790 INTERASSE MM. 37



**SERRATURA AD INFILARE
CON PREDISPOSIZIONE
CILINDRO EUROPEO
TRIPLICE REVERSIBILE
ART. 678.0028.0GF0**

104791 INTERASSE MM. 28

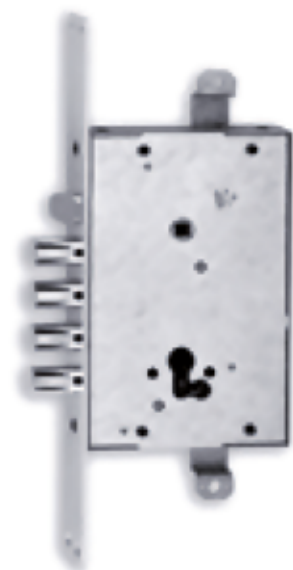

**SERRATURA AD INFILARE
CON PREDISPOSIZIONE
CILINDRO EUROPEO
TRIPLICE REVERSIBILE
ART. 678.0037.0GF0**

104792 INTERASSE MM. 37





**SERRATURA DA APPLICARE
CON PREDISPOSIZIONE
CILINDRO EUROPEO
TRIPLICE REVERSIBILE
ART. 668.0328.0G04**

104793 INTERASSE MM. 28



**SERRATURA DA APPLICARE
CON PREDISPOSIZIONE
CILINDRO EUROPEO
TRIPLICE REVERSIBILE
ART. 668.0337.0G04**

104794 INTERASSE MM. 37

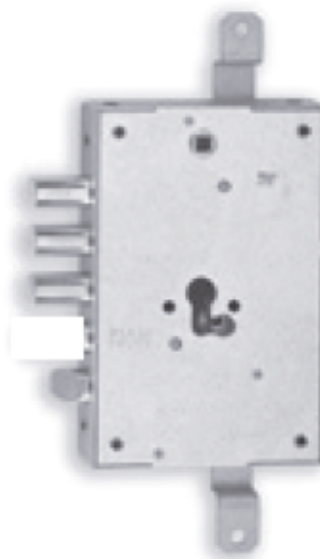

**SERRATURA DA APPLICARE
CON PREDISPOSIZIONE
CILINDRO EUROPEO
TRIPLICE REVERSIBILE
SCROCCO AVANZATO CM. 1
ART. 668.1328.0G04**

104795 INTERASSE MM. 28

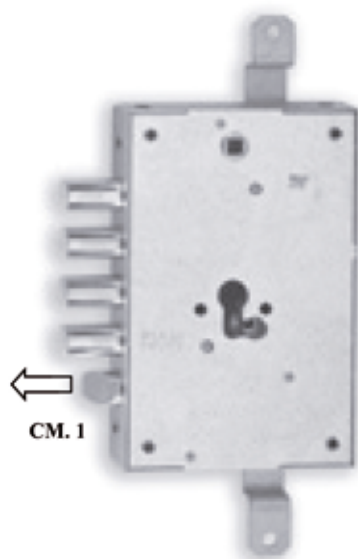

**SERRATURA DA APPLICARE
CON PREDISPOSIZIONE
CILINDRO EUROPEO
TRIPLICE REVERSIBILE
SCROCCO AVANZATO CM. 1
ART. 668.1337.0G04**

104796 INTERASSE MM. 37

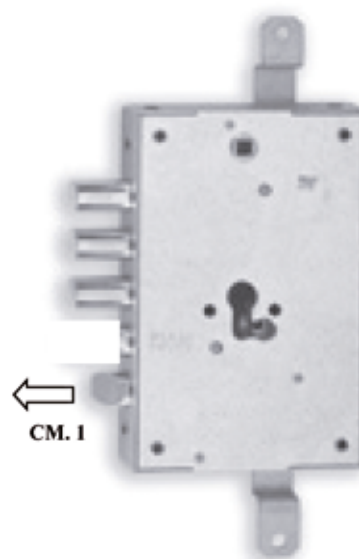



**SERRATURA AD APPLICARE
CON PREDISPOSIZIONE
CILINDRO EUROPEO TRIPLICE
REVERSIBILE
ART. 668.0328.OGF4**

104850 INTERASSE MM. 28

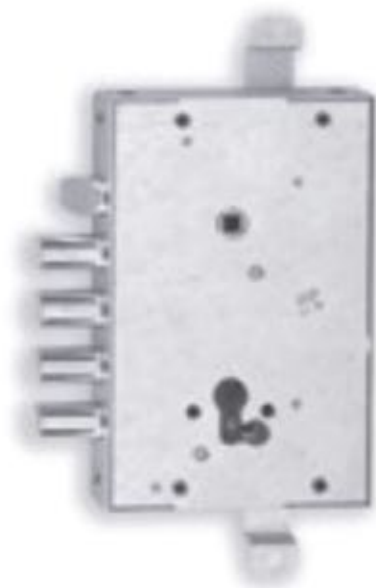

**SERRATURA AD APPLICARE
CON PREDISPOSIZIONE
CILINDRO EUROPEO TRIPLICE
REVERSIBILE
ART. 668.0338.OGF4**

104851 INTERASSE MM. 38

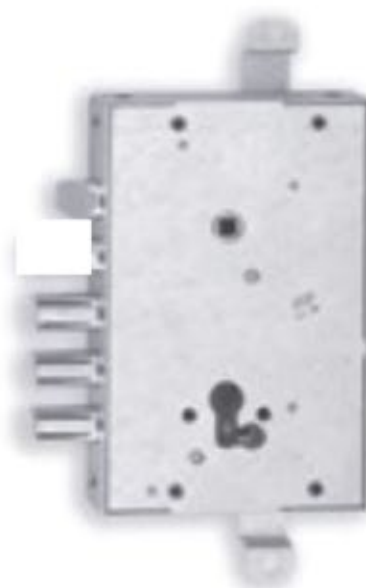

**SERRATURA AD APPLICARE
CON PREDISPOSIZIONE
CILINDRO EUROPEO TRIPLICE
REVERSIBILE
SCROCCO AVANZATO CM. 1
ART. 668.1328.OGF4**

104852 INTERASSE MM. 28

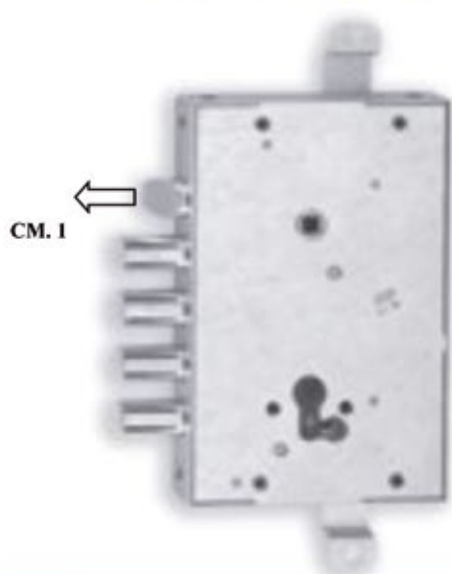

**SERRATURA AD APPLICARE
CON PREDISPOSIZIONE
CILINDRO EUROPEO TRIPLICE
REVERSIBILE
SCROCCO AVANZATO CM. 1
ART. 668.1338.OGF4**

104853 INTERASSE MM. 38

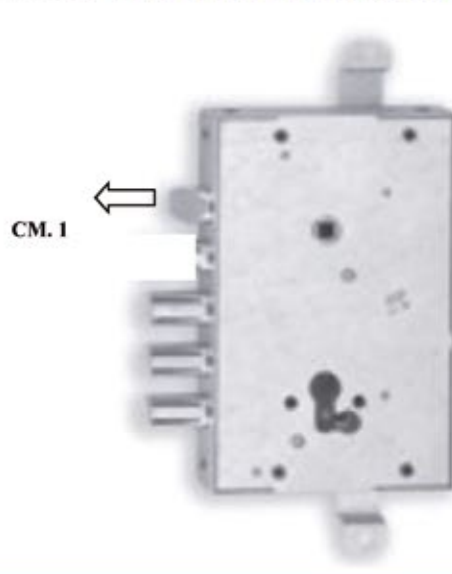

**SERRATURA DA APPLICARE
CON PREDISPOSIZIONE
CILINDRO EUROPEO TRIPLICE
REVERSIBILE
ENTRATA MM. 73 MOD. DIERRE
ART. 668.0328.0G70**

104854 INTERASSE MM. 28



**SERRATURA DA APPLICARE
CON PREDISPOSIZIONE
CILINDRO EUROPEO TRIPLICE
REVERSIBILE
ENTRATA MM. 73 MOD. DIERRE
ART. 668.0337.0G70**

104855 INTERASSE MM. 37



**SERRATURA DA APPLICARE
CON PREDISPOSIZIONE
CILINDRO EUROPEO TRIPLICE
REVERSIBILE
ENTRATA MM. 89 MOD. GARDESA
ART. 668.0537.0G80**

104856 INTERASSE MM. 37



**INCONTRO ELETTRICO
REVERSIBILE INOX
ART. 5661900**

104281 MM. 250X25X3



**INCONTRO ELETTRICO
PER SERRATURE
CON FRONTALE ACCIAIO
CROMATO
INTERASSE MM. 28
ART. E 600**

**104860 DESTRO
20028E60012V1**

**104861 SINISTRO
20028E60012V2**



**INCONTRO ELETTRICO
PER SERRATURE
CON FRONTALE ACCIAIO
CROMATO
INTERASSE MM. 37
ART. E 600**

**104862 DESTRO
20037E60012V1**

**104863 SINISTRO
20037E60012V2**



**INCONTRO ELETTRICO
PER ANTIPANICO
ART. 5680000**

104864 VERNICIATO NERO



**MANIGLIA E CILINDRO
PER ANTIPANICO
ART. 94021005**

104865 VERNICIATO NERO





**MANIGLIONE ANTIPANICO
MODULARE
MODELLO IDEA
SCROCCO IN ZAMA
ART. 9414000505**

104866 VERNICIATO NERO



**BARRA DI SPINTA OVALE
MODELLO IDEA
ART. 945928**

**104867 VERNICIATO ROSSO
CM. 213**



**COPPIA SCROCCHI
PER ANTIPANICO
MODELLO IDEA
SCROCCHI IN ZAMA
PER CHIUSURA VERTICALE
ART. 9410201505**

104868 VERNICIATO NERO

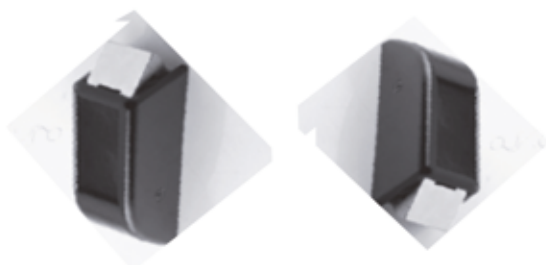

**ASTE E COPERTURE
PER ANTIPANICO
MODELLO IDEA
PER CHIUSURA VERTICALE
ART. 94100205**

**104869 VERNICIATO NERO
H MAX CM. 240**





**CHIUDIPIORTA AEREODINAMICO
S/FERMO FORZA 2-3
ART. IS 20**

104285 NERO ART. 371100005

104286 ARGENTO ART. 371100003



**CHIUDIPIORTA AEREODINAMICO
C/FERMO FORZA 2-3
ART. IS 20**

104287 NERO ART. 371101005

104288 ARGENTO ART. 371101003



**CHIUDIPIORTA AEREODINAMICO
S/FERMO FORZA 2-3-4
ART. IS 60**

104289 NERO ART. 372100005

104290 ARGENTO ART. 372100003



**CHIUDIPIORTA AEREODINAMICO
C/FERMO FORZA 2-3-4
ART. IS 60**

104291 NERO ART. 372101005

104292 ARGENTO ART. 372101003





TSEO[®]

FIAM.[®]

Kassel[®]



NOVA-FERR srl



Accessori per serramenti e chiusure industriali



NEW !!!

Serrature



Cardini



Accessori portoni industriali



Cerniere



Carrelli



Accessori



Ruote



Ornamenti



NOVA-FERR srl



**SERRATURA DA APPLICARE
DOPPIA MAPPA**

104615 ART. 1151 DX

104616 ART. 1152 SX



**SERRATURA DA APPLICARE
DOPPIA MAPPA
TRIPLICE**

104600 ART. 1351 DX

104601 ART. 1352 SX



**SERRATURA DA APPLICARE
DOPPIA MAPPA
QUINTUPLICE**

104602 ART. 1551 DX

104603 ART. 1552 SX



CON DEVIATORE

**RICAMBIO GORGES
PER SERRATURE DOPPIA MAPPA
SERIE 1150/1350/1550**

104617 DX

104618 SX





**SERRATURA DA APPLICARE
A POMPA
TRIPLICE**

104604 ART. 4351 DX
104605 ART. 4352 SX



**SERRATURA DA APPLICARE
A POMPA
QUINTUPLICE**

104606 ART. 4551 DX
104607 ART. 4552 SX



CON DEVIATORE

CILINDRO A POMPA

104610 MM. 60

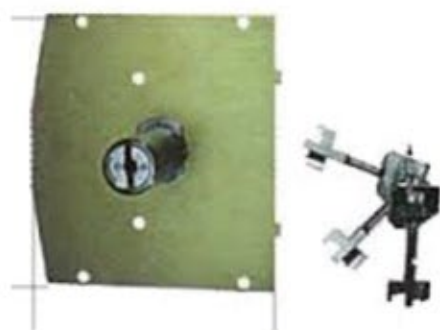

ASTE DI RICAMBIO

104611 PER TRIPLICE



104612 PER QUINT.



Meroni[®] serrature



Meroni[®] serrature

pigio[®]



**PREMI APRI
BLOCCABILE O SBLOCCABILE
DALL'ESTERNO CON CHIAVE DALL'INTERNO CON GIREVOLE
FINITURA ARGENTO
ART. N13**

191050 ENTRATA MM. 60

191051 ENTRATA MM. 70

191052 ENTRATA MM. 80



**PREMI APRI
BLOCCABILE O SBLOCCABILE
DALL'ESTERNO CON CHIAVE DALL'INTERNO CON GIREVOLE
FINITURA NERO
ART. N13**

191053 ENTRATA MM. 60

191054 ENTRATA MM. 70

191055 ENTRATA MM. 80



PIGIO PER BAGNI
APERTURA ESTERNA CON MONETA CACCIAVITE
MANIGLIA INTERNA CON GIREVOLE CHE AZIONA IL
SEGNALE OCCUPATO, CON FUNZIONE ANTIPANICO UNI EN 179
FINITURA GRIGIO CHIARO MANIGLIA GRIGIO SCURO
CON CONTROBORDO QUADRO ART. 1215
ART. P12E

191060 ENTRATA MM. 60

191061 ENTRATA MM. 70

191062 ENTRATA MM. 80

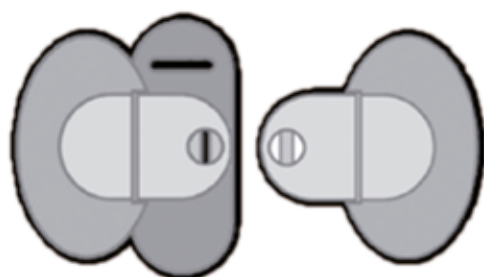

PIGIO PER INGRESSI E UFFICI
BLOCCABILE E SBLOCCABILE DALL'ESTERNO CON CHIAVE
DALL'INTERNO CON GIREVOLE, CON FUNZIONE
DI TIPO ANTIPANICO UNI EN 179
FINITURA GRIGIO CHIARO MANIGLIA GRIGIO SCURO
CON CONTROBORDO QUADRO ART. 1215
ART. P13E

191065 ENTRATA MM. 60

191066 ENTRATA MM. 70

191067 ENTRATA MM. 80

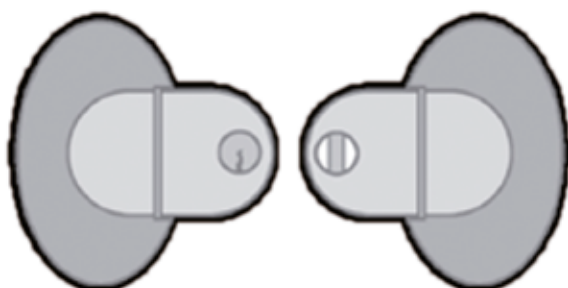





MOIA

PIU' FORTE DENTRO



MADE IN ITALY

DAL 1957

PRODUZIONE SERRATURE DI SICUREZZA
DOPPIA MAPPA - A POMPA - A PROFILO EUROPEO
ANTI GRIMALDELLO BULGARO A LEVE E INGRANAGGI

PRODOTTO DA

OMR



O.M.R. SRL
VIA TETTI DELL'OLEO, 55
10071 - BORGARO TORINESE (TO)

WWW.OMRSERRATURE.IT
INFO@OMRSERRATURE.IT



**SERRATURA
APPLICARE DOPPIA MAPPA
TRIPLICE
ART. 414**

104700 DX

104701 SX

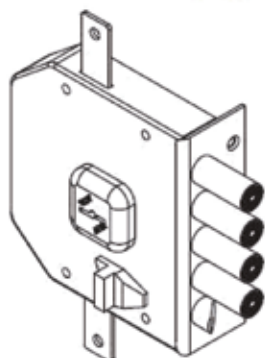

**SERRATURA
APPLICARE DOPPIA MAPPA
QUINTUPLICE
ART. 416**

104702 DX

104703 SX

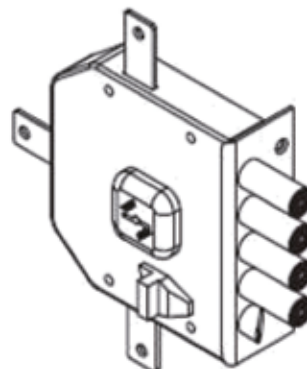

**SERRATURA
APPLICARE POMPA
TRIPLICE
ART 434**

104704 DX

104705 SX

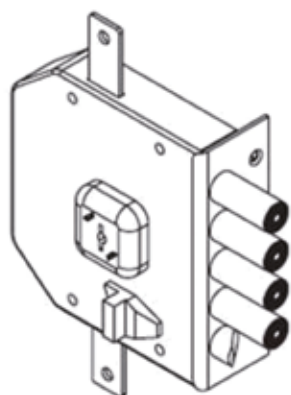

**SERRATURA
APPLICARE POMPA
QUINTUPLICE
ART 436**

104706 DX

104707 SX

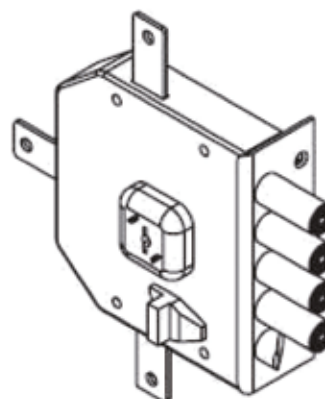

**SERRATURA APPLICARE
A CILINDRO
ART.350 REVERSIBILE
CUCCIOLO**

104720 MM. 55

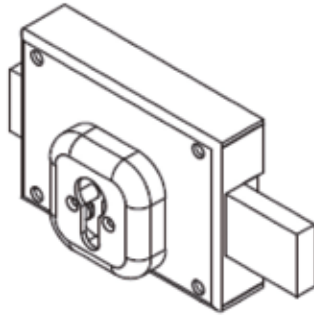

**ASTE
PER SERRATURA TRIPLICE**

104710 CON ACCESSORI



**ASTE E DEVIATORE
PER SERRATURA QUINTUPLICE**

104711 CON ACCESSORI

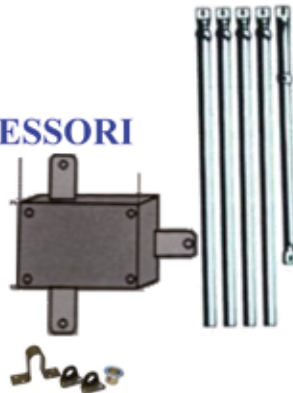

**RICAMBIO GORGES
PER DOPPIA MAPPA
ART. 181**

**104712 DX
104713 SX**



**RICAMBIO GORGES
PER DOPPIA MAPPA ART. 181
PER VECCHIO MODELLO**

104714 REVERS.



**RICAMBIO POMPA
ART.175/4
CON PIASTRA**

104715 MM. 60







safeguarding your security



MOTTURA



MOTTURA X TECHNOLOGY



MOTTURA
AUTOMATIC

MOTTURA

Sono marchi Mottura Serrature di Sicurezza S.p.A.

AZIENDA CON SISTEMI
DI GESTIONE QUALITÀ
CERTIFICATO DA BSI
- ISO 9001 -

www.mottura.it



Rivolgiti con fiducia
ai Centri d'installazione
chiavi protette



**SERRATURA APPLICARE
DOPPIA MAPPA
ART.20511**

103475 20511 DX

103476 20511 SX



**SERRATURA APPLICARE
DOPPIA MAPPA TRIPLICE
ART.20537**

103412 20537 DX

103413 20537 SX



**SERRATURA APPLICARE
DOPPIA MAPPA
ART. 20500**

103477 20500 DX

103478 20500 SX



**SERRATURA APPLICARE
DOPPIA MAPPA
ART. 20510**

103340 20510 DX

103341 20510 SX



**SERRATURA APPLICARE
DOPPIA MAPPA TRIPLICE
ART.20520**

103342 20520 DX

103343 20520 SX

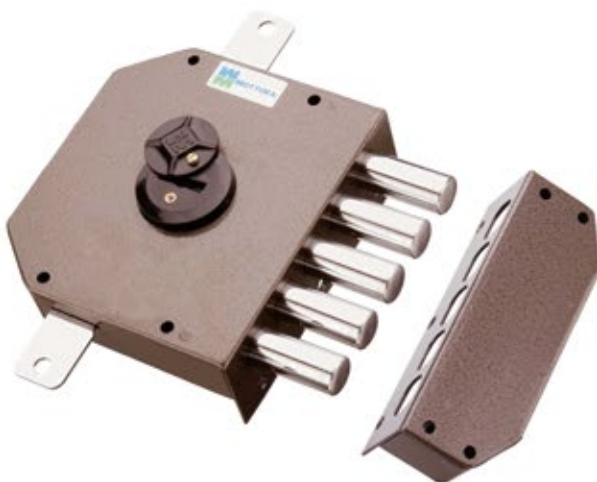

**SERRATURA APPLICARE
DOPPIA MAPPA TRIPLICE
ART. 20530**

103344 20530 DX

103345 20530 SX

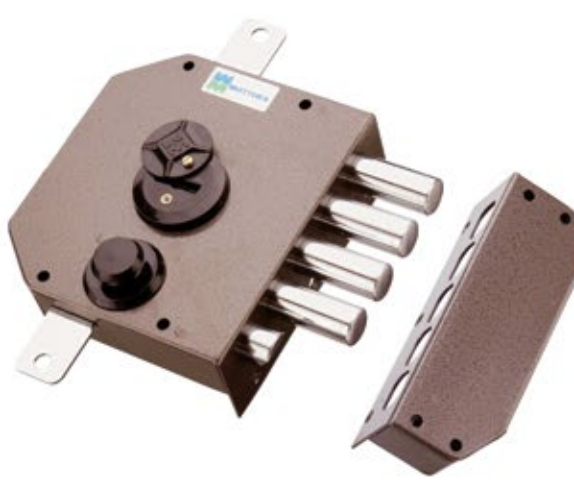

**SERRATURA APPLICARE
DOPPIA MAPPA QUINTUPLICE
ART.20540**

103346 20540 DX

103347 20540 SX



**SERRATURA APPLICARE
DOPPIA MAPPA QIUNTUPLICE
ART. 20550**

103348 20550 DX

103349 20550 SX

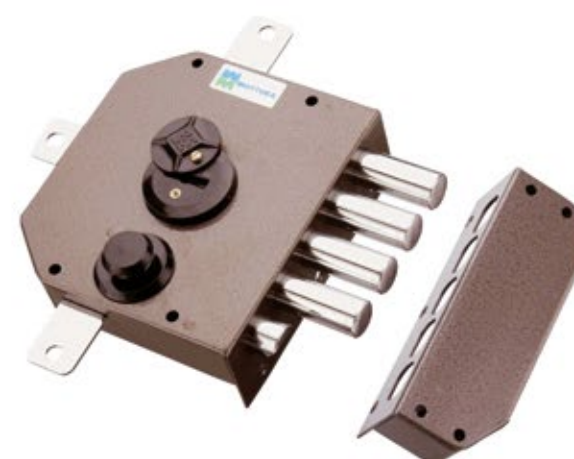

**SERRATURA APPLICARE
A POMPA MM. 34 TRIPLICE
ART. 30436**

103385 30436 DX

103386 30436 SX



**SERRATURA APPLICARE
A POMPA MM. 34
ART. 30610**

103328 30610 DX

103329 30610 SX



**SERRATURA APPLICARE
A POMPA MM. 34 TRIPLICE
ART. 30620**

103332 30620 DX

103333 30620 SX



**SERRATURA APPLICARE
A POMPA MM. 34 TRIPLICE
ART. 30630**

103330 30630 DX

103331 30630 SX



**SERRATURA APLICARE
POMPA MM. 34 QUINTUPLICE
ART. 30640**

103334 30640 DX

103335 30640 SX



**SERRATURA APLICARE
POMPA MM. 34 QUINTUPLICE
ART. 30650 DX**

103338 30650 DX

103339 30650 SX



**SERRATURA APLICARE
A POMPA MM. 34 TRIPLICE
ELETTRICA
ART. 30E30**

103420 30E30 DX

103421 30E30 SX



**SERRATURA
A POMPA MM. 34 TRIPLICE
ELETTRICA
CILINDRO EUROPEO
ART.30E30**

104580 30E30C10 DX

105581 30E30C10 SX

104582 30E30C28 DX

104583 30E30C28 SX

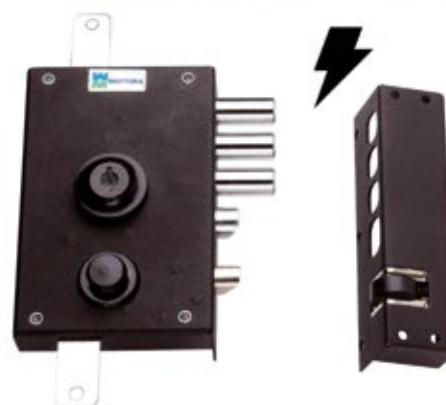



**SERRATURA APPLICARE
PREDISPOSIZIONE
CILINDRO EUROPEO
ART. 38610**

104080 38610 DX
104081 38610 SX



**SERRATURA APPLICARE
PREDISPOSIZIONE
CILINDRO EUROPEO
TRIPLICE ART. 38620**

104082 38620 DX
104083 38620 SX

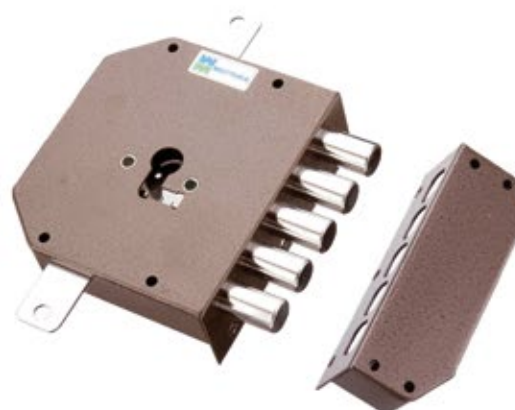

**SERRATURA APPLICARE
PREDISPOSIZIONE
CILINDRO EUROPEO
TRIPLICE ART. 38630**

104084 38630 DX
104085 38630 SX

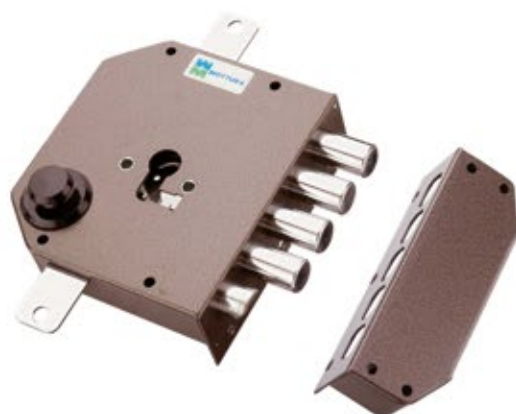

**SERRATURA APPLICARE
PREDISPOSIZIONE
CILINDRO EUROPEO
QUINTUPLICE ART. 38640**

104086 38640 DX
104087 38640 SX

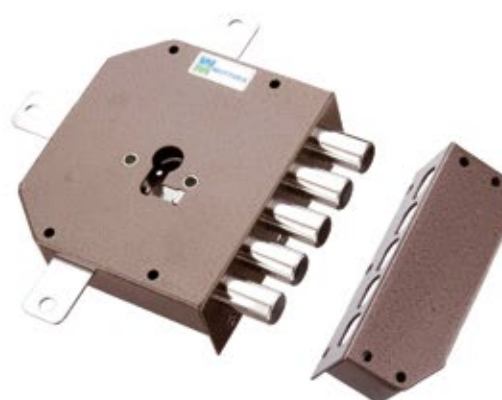

**SERRATURA APPLICARE
PREDISPOSIZIONE
CILINDRO EUROPEO
QUINTUPLICE ART. 38650**

104089 38650 DX
104090 38650 SX



**SERRATURA APPLICARE
CON CIL. EUROPEO 31/61 C 28
E DEFENDER
TRIPLICE ART. 38632SC6**

104634 38632SC6DC28 DX
104635 38632SC6SC28 SX



**SERRATURA APPLICARE
POMPA MM. 34
CILINDRO EUROPEO
ART.30610**

104620 30610 DX C10
104621 30610 SX C10



**SERRATURA APPLICARE
POMPA MM. 34
CILINDRO EUROPEO
TRIPLICE ART.30620**

104624 30620 DX C10
104625 30620 SX C10



**SERRATURA APPLICARE
POMPA MM. 34
CILINDRO EUROPEO
TRIPLICE ART.30630**

104055 30630 DX C10
104056 30630 SX C10



**SERRATURA APPLICARE
POMPA MM. 34
CILINDRO EUROPEO
QUINTUPLICE ART. 30640**

104628 30640 DX C10
104629 30640 SX C10



**SERRATURA APPLICARE
POMPA MM. 34
CILINDRO EUROPEO
QUINTUPLICE ART. 30650**

104057 30650 DX C10
104058 30650 SX C10



**SERRATURA APPLICARE
POMPA MM. 34
CILINDRO EUROPEO
ART.30610**

104622 30610 DX C28
104623 30610 SX C28



**SERRATURA APPLICARE
POMPA CILINDRO EUROPEO
TRIPLICE ART.30620**

104626 30620 DX C28
104627 30620 SX C28



**SERRATURA APPLICARE
POMPA CILINDRO EUROPEO
TRIPLICE ART.30630**

104104 30630 DX C28
104105 30630 SX C28



**SERRATURA APPLICARE
POMPA CILINDRO EUROPEO
QUINTUPLICE ART. 30640**

104630 30640 DX C28
104631 30640 SX C28



**SERRATURA APPLICARE
POMPA CILINDRO EUROPEO
QUINTUPLICE ART. 30650**

104632 30650 DX C28
104633 30650 SX C28

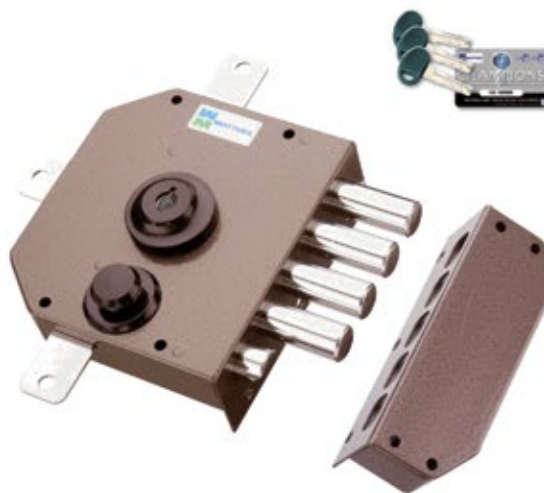

**SERRATURA DOPPIA MAPPA
INFILARE
4 MANDATE 2 CHIAVI
ART. 40702**

103416 ENTRATA MM. 50
103417 ENTRATA MM. 60
103418 ENTRATA MM. 70

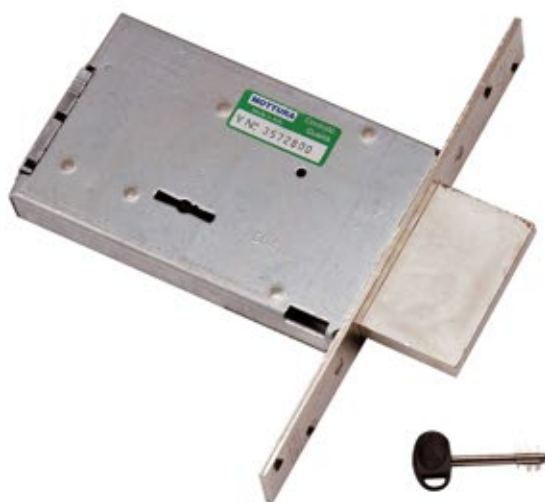

**SERRATURA DOPPIA MAPPA
INFILARE
4 MANDATE 1 CHIAVE
ART. 40704
KA CHIAVE UNICA**

103480 ENTRATA MM. 50
103481 ENTRATA MM. 60
103482 ENTRATA MM. 70



**SERRATURA DOPPIA MAPPA
INFILARE
2 MANDATE REVERSIBILE
ART. 40711**

103400 ENTRATA MM. 50

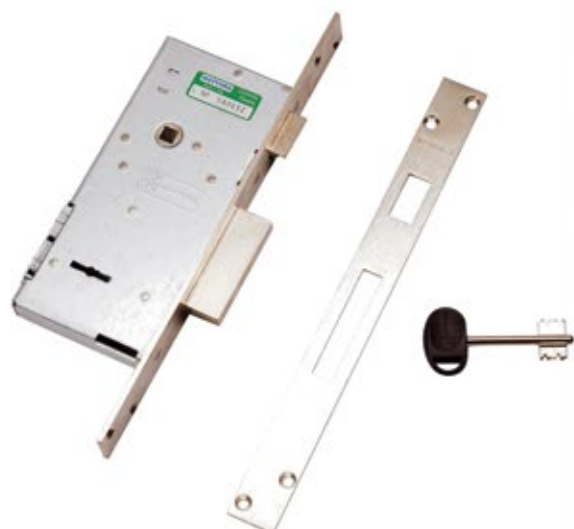

**SERRATURA DOPPIA MAPPA
INFILARE TRIPLICE
2 MANDATE REVERSIBILE
ART. 40721**

103401 ENTRATA MM. 50



**SERRATURA DOPPIA MAPPA
INFILARE
4 MANDATE REVERSIBILE
ART. 40731**

103402 ENTRATA MM. 60

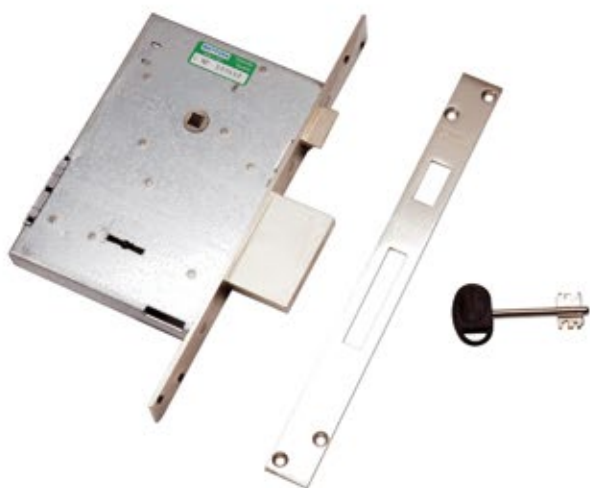

**SERRATURA DOPPIA MAPPA
INFILARE TRIPLICE
4 MANDATE REVERSIBILE
ART. 40741**

103403 ENTRATA MM. 60

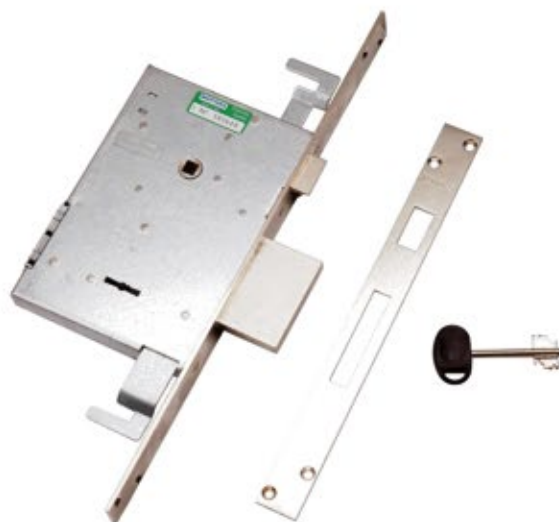

**SERRATURA DOPPIA MAPPA
INFILARE
4 MANDATE REVERSIBILE
ART. 41812
CONFEZIONE INDUSTRIALE**

103390 ENTRATA MM. 70



**SERRATURA DOPPIA MAPPA
INFILARE TRIPLICE
4 MANDATE REVERSIBILE
ART. 41823
CONFEZIONE INDUSTRIALE**

103391 ENTRATA MM. 70

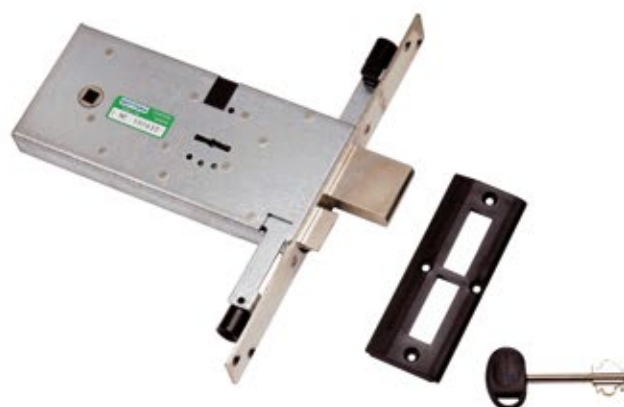



**SERRATURA DOPPIA MAPPA
INFILARE 4 MANDATE
REVERSIBILE INTERASSE MM. 28
ART. 52770**

103356 ENTRATA MM. 63



**SERRATURA DOPPIA MAPPA
INFILARE TRIPLICE 4 MANDATE
REVERSIBILE INTERASSE MM. 28
CON SBALZI E CHIAVE SERVIZIO
ART. 52771**

103355 ENTRATA MM. 63

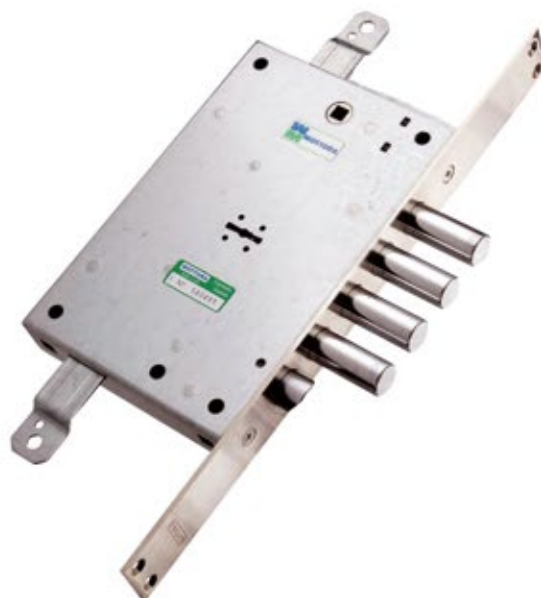

**SERRATURA DOPPIA MAPPA
AD APPLICARE TRIPLICE
4 MANDATE
REVERSIBILE INTERASSE MM. 28
ART. 52571/28**

104636 ENTRATA MM. 63



**SERRATURA DOPPIA MAPPA
AD APPLICARE TRIPLICE
4 MANDATE
REVERSIBILE INTERASSE MM. 37
ART. 52571/37**

104637 ENTRATA MM. 63



**SERRATURA DOPPIA MAPPA
INFILARE 4 MANDATE
A DUE CHIUSURE
CON CHIAVE DI SERVIZIO
ART. 54794**

**103380 ENTRATA MM. 63 DX
103381 ENTRATA MM. 63 SX**



**SERRATURA DOPPIA MAPPA
INFILARE 4 MANDATE TRIPLICE
A DUE CHIUSURE CON SBALZI E
CHIAVE DI SERVIZIO
ART. 54795**

**103382 ENTRATA MM. 63 DX
103383 ENTRATA MM. 63 SX**



**SERRATURA DOPPIA MAPPA
INFILARE TRIPLICE
A 2 CHIUSURE
PREDISPOSIZIONE CILINDRO EU
ART. 54797**

**104050 ENTRATA MM. 63 DX
104051 ENTRATA MM. 63 SX**

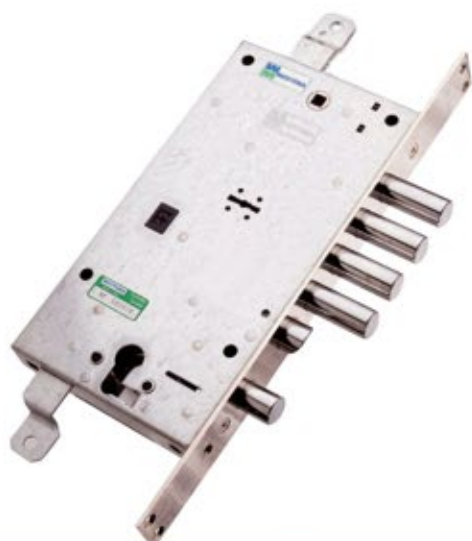

**SERRATURA DOPPIA MAPPA
INFILARE TRIPLICE
A 2 CHIUSURE
PREDISPOSIZIONE CILINDRO EU
ART. 54K797MY KEY**

**104110 ENTRATA MM. 63 DX
104111 ENTRATA MM. 63 SX**





**SERRATURA DOPPIA MAPPA
AD APPLICARE TRIPLICE
ENTRATA MM. 70
ART. 64561**

104640 DESTRA

104641 SINISTRA



**SERRATURA DOPPIA MAPPA
AD APPLICARE TRIPLICE
ENTRATA MM. 70
ART. 64561 0Z1**

104642 DESTRA

104643 SINISTRA



CHIAVISTELLI AVANZATI MM. 40

**SERRATURA DOPPIA MAPPA
AD APPLICARE TRIPLICE
ENTRATA MM. 70
ART. 64561 LZ1**

104644 DESTRA

104645 SINISTRA



**CHIAVISTELLI AVANZATI MM. 40
ATTACCHI LATERALI**

**SERRATURA DOPPIA MAPPA
AD APPLICARE TRIPLICE
ENTRATA MM. 70
ART. 64561 MALS**

104646 DESTRA

104647 SINISTRA



ATTACCHI LATERALI

**SERRATURA DOPPIA MAPPA
INFILARE
SENZA MEZZO GIRO
ART. 72110**

103405 ENTRATA MM. 47



**SERRATURA DOPPIA MAPPA
INFILARE
CON MEZZO GIRO
REVERSIBILE
ART. 72120**

103357 ENTRATA MM. 47



**SERRATURA DOPPIA MAPPA
INFILARE
CON RULLO
ART. 72125**

103358 ENTRATA MM. 47



**SERRATURA DOPPIA MAPPA
INFILARE TRIPLICE
SENZA MEZZO GIRO
ART. 72130**

103407 ENTRATA MM. 47





**SERRATURA DOPPIA MAPPA
INFILARE TRIPLICE
CON MEZZO GIRO
ART. 72140**

103359 ENTRATA MM. 47



**SERRATURA DOPPIA MAPPA
INFILARE TRIPLICE
CON RULLO
ART. 72145**

103406 ENTRATA MM. 47

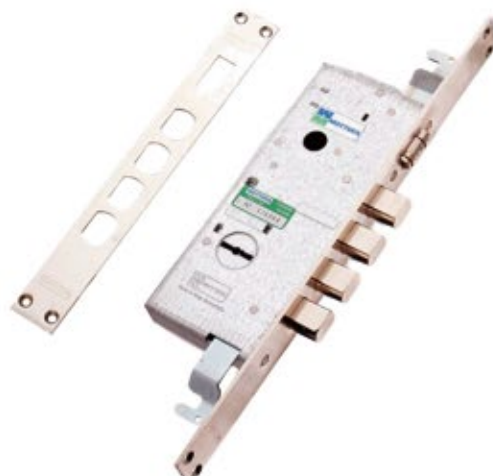

**SERRATURA DOPPIA MAPPA
INFILARE TRIPLICE
CON MEZZO GIRO ELETTRICA
ART. 7214 ELE**

103415 ENTRATA MM. 47

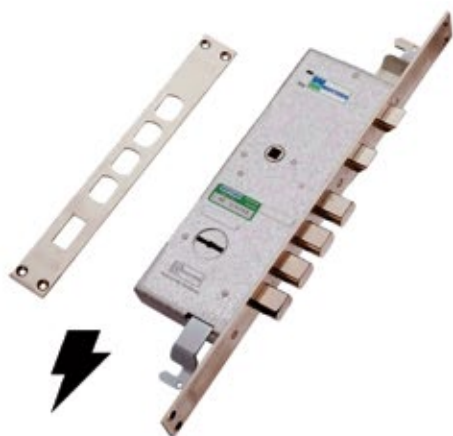

**SERRATURA DOPPIA MAPPA
INFILARE
ART. 72778**

103408 ENTRATA MM. 64 DX

103409 ENTRATA MM. 64 SX



**SERRATURA DOPPIA MAPPA
INFILARE TRIPLICE
ART. 72779**

103410 ENTRATA MM. 64 DX

103411 ENTRATA MM. 64 SX



**SERRATURA INFILARE
ELETTRICA TRIPLICE
CON PREDISPOSIZIONE
CILINDRO EUROPEO
ART. 8597 ELE**

104044 ENTRATA MM. 63 DX

104045 ENTRATA MM. 63 SX



**SERRATURA AD APPLICARE
ELETTRICA TRIPLICE
CON PREDISPOSIZIONE
CILINDRO EUROPEO
ART. 8537 ELE**

104046 ENTRATA MM. 63 DX

104047 ENTRATA MM. 63 SX

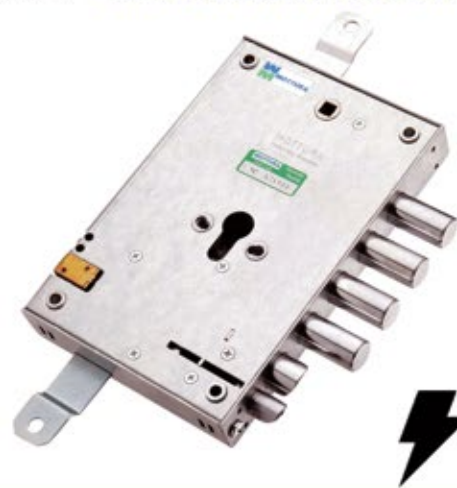



**SERRATURA INFILARE
SENZA MEZZO GIRO
PREDISPOSIZIONE
CILINDRO EUROPEO
AMBIDESTRO
ART. 85110**

104070 ENTRATA MM. 49



**SERRATURA INFILARE
CON MEZZO GIRO
REVERSIBILE
PREDISPOSIZIONE
CILINDRO EUROPEO
ART. 85120**

104071 ENTRATA MM. 49



**SERRATURA INFILARE
CON RULLO
CON PREDISPOSIZIONE
CILINDRO EUROPEO
AMBIDESTRO
ART. 85125**

104072 ENTRATA MM. 49



**SERRATURA INFILARE
TRIPLICE
SENZA MEZZO GIRO
CON PREDISPOSIZIONE
CILINDRO EUROPEO
AMBIDESTRO
ART. 85130**

104073 ENTRATA MM. 49



**SERRATURA INFILARE
TRIPLICE
CON MEZZO GIRO
PREDISPOSIZIONE CILINDRO
EUROPEO REVERSIBILE
ART. 85140**

104074 ENTRATA MM. 49



**SERRATURA INFILARE
TRIPLICE
CON RULLO
PREDISPOSIZIONE CILINDRO
EUROPEO REVERSIBILE
ART. 85145**

104075 ENTRATA MM. 49



**SERRATURA INFILARE
CON PREDISPOSIZIONE
CILINDRO EUROPEO
REVERSIBILE
ART.85778**

104076 ENTRATA MM. 64



**SERRATURA INFILARE TRIPLICE
CON PREDISPOSIZIONE
CILINDRO EUROPEO
REVERSIBILE
ART. 85779**

104077 ENTRATA MM 64



**SERRATURA AD APPLICARE
TRIPLICE
CON PREDISPOSIZIONE
CILINDRO EUROPEO
INTERASSE MM. 28
ART. 85461**

104112 ENTRATA MM. 70 DX
104113 ENTRATA MM. 70 SX



**SERRATURA AD APPLICARE
TRIPLICE
CON PREDISPOSIZIONE
CILINDRO EUROPEO
INTERASSE MM. 28
ART. 85571**

104114 ENTRATA MM. 63 DX
104115 ENTRATA MM. 63 SX



**SERRATURA AD INFILARE
TRIPLICE
CON PREDISPOSIZIONE
CILINDRO EUROPEO
INTERASSE MM. 28
CON FERROGLIERA E SBALZI
ART. 85771**

104078 ENTRATA MM. 63 DX
104079 ENTRATA MM. 63 SX



**SERRATURA AD INFILARE
TRIPLICE
CON PREDISPOSIZIONE
CILINDRO EUROPEO
INTERASSE MM. 37
ART. 85771**

104116 ENTRATA MM. 63 DX
104117 ENTRATA MM. 63 SX



**SERRATURA AD INFILARE
TRIPLICE
CON PREDISPOSIZIONE
CILINDRO EUROPEO
ART. 85783**

104040 ENTRATA MM. 63 DX
104041 ENTRATA MM. 63 SX

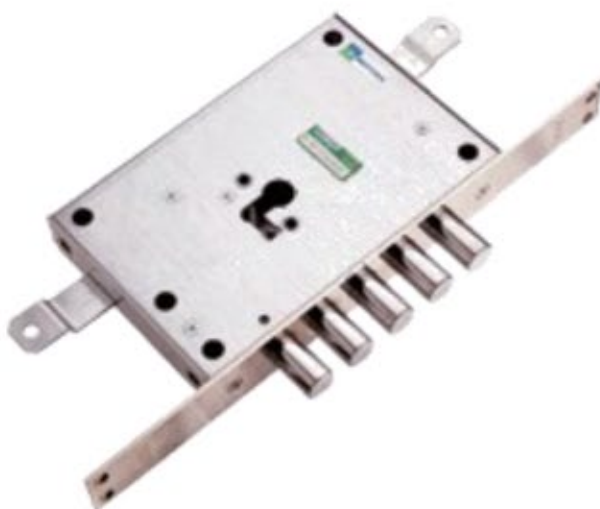

**SERRATURA AD INFILARE
TRIPLICE
CON DOPPIA PREDISPOSIZIONE
CILINDRO EUROPEO
ART. 85795**

104042 ENTRATA MM. 63 DX
104043 ENTRATA MM. 63 SX



**SERRATURA AD INFILARE
TRIPLICE DOPPIA MAPPA
INTERASSE MM. 28
MODELLO MEBA
ART.89771MEB**

104326 ENTRATA MM. 63 DX
104327 ENTRATA MM. 63 SX



**SERRATURA AD INFILARE
TRIPLICE
CON PREDISPOSIZIONE
CILINDRO EUROPEO
INTERASSE MM. 28
MODELLO MEBA
ART. 898771MBQ**

104328 ENTRATA MM. 63 DX
104329 ENTRATA MM. 63 SX



**SERRATURA AD APPLICARE
TRIPLICE DOPPIA MAPPA
INTERASSE MM. 37
MODELLO CIR
ART.89571B37**

104093 ENTRATA MM. 63 DX
104094 ENTRATA MM. 63 SX



**SERRATURA AD APPLICARE
TRIPLICE
CON PREDISPOSIZIONE
CILINDRO EUROPEO
INTERASSE MM. 37 MOD. CIR
ART. 898571B7Q**

104060 ENTRATA MM. 63 DX
104061 ENTRATA MM. 63 SX



**SERRATURA AD APPLICARE
TRIPLICE DOPPIA MAPPA
CON NUCLEO QUICK
INTERASSE MM. 28 MOD. DIERRE
ART.89K571 DRB**

104062 ENTRATA MM. 73 DX
104063 ENTRATA MM. 73 SX



**SERRATURA AD APPLICARE
TRIPLICE
CON PREDISPOSIZIONE
CILINDRO EUROPEO
INTERASSE MM. 28 MOD DIERRE
ART. 89371 DERT**

104064 ENTRATA MM. 73 DX
104065 ENTRATA MM. 73 SX



**SERRATURA AD APPLICARE
TRIPLICE
CON PREDISPOSIZIONE
CILINDRO EUROPEO
INTERASSE MM. 37 MOD. DIERRE
ART. 89371DE7T**

104066 ENTRATA MM.73 DX
104067 ENTRATA MM.73 SX



**SERRATURA AD APPLICARE
TRIPLICE DOPPIA MAPPA
INTERASSE MM. 37
MODELLO GARDESA
ART.89R571G9**

103489 ENTRATA MM. 89 DX
103490 ENTRATA MM. 89 SX



**SERRATURA AD APPLICARE
TRIPLICE
CON PREDISPOSIZIONE
CILINDRO EUROPEO
INTERASSE MM. 37
MODELLO GARDESA
ART. 898571G9Q**

104068 ENTRATA MM. 89 DX
104069 ENTRATA MM. 89 SX

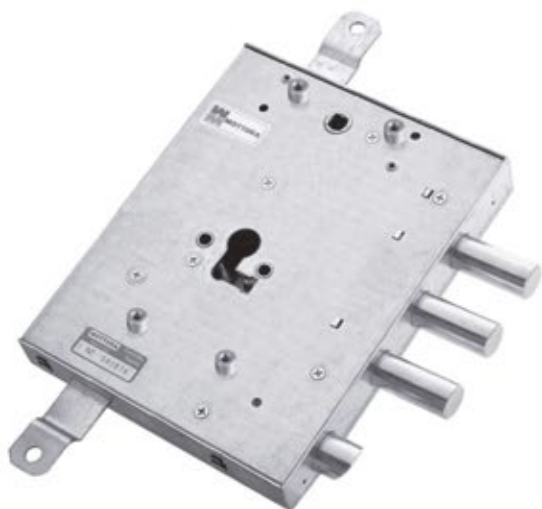

**SERRATURA AD APPLICARE
TRIPLICE DOPPIA MAPPA
INTERASSE M.37
MODELLO GARDESA
ART. 89R571G17**

103487 ENTRATA MM. 89 DX
103488 ENTRATA MM. 89 SX





**SERRATURA AD APPLICARE
TRIPLICE
CON PREDISPOSIZIONE
CILINDRO EUROPEO
INTERASSE MM. 37
MOD. GARDESA
ART.898571GRQ**

104320 ENTRATA MM. 89 DX
104321 ENTRATA MM. 89 SX



**SERRATURA AD APPLICARE
TRIPLICE DOPPIA MAPPA
INTERASSE MM. 25
MODELLO GARDESA
ART. 89555GAR**

104322 ENTRATA MM. 63 DX
104323 ENTRATA MM. 63 SX



**SERRATURA AD APPLICARE
TRIPLICE
CON PREDISPOSIZIONE
CILINDRO EUROPEO
INTERASSE MM. 25
MOD. GARDESA
ART.898555GRT**

104324 ENTRATA MM. 63 DX
104325 ENTRATA MM. 63 SX



**SERRATURA AD APPLICARE
TRIPLICE
CON PREDISPOSIZIONE
CILINDRO EUROPEO
INTERASSE MM. 37
MOD. ALIAS
ART. 8946717AQ**

104648 ENTRATA MM. 63 DX
104649 ENTRATA MM. 63 SX



CASSEFORTI MOTTURA
SERIE NUOVA SPECIAL
CHIUSURA A CHIAVE

103900	ART. 116312	<u>H 170 L 265 P 200</u>
103901	ART. 116322	<u>H 200 L 290 P 200</u>
103902	ART. 116332	<u>H 240 L 330 P 200</u>
103903	ART. 116342	<u>H 290 L 390 P 200</u>
103904	ART. 116343	<u>H 290 L 390 P 250</u>
103905	ART. 116372	<u>H 330 L 240 P 200</u>



CASSEFORTI MOTTURA
SERIE PERSONAL

CHIUSURA A CHIAVE E COMBINAZIONE MECCANICA

103906	ART. 112120	<u>H 230 L 350 P 200</u>
103907	ART. 112220	<u>H 290 L 410 P 200</u>
103908	ART. 112320	<u>H 360 L 460 P 200</u>
103911	ART. 112125	<u>H 230 L 350 P 250</u>
103909	ART. 112225	<u>H 290 L 410 P 250</u>
103910	ART. 112325	<u>H 360 L 460 P 250</u>





**CILINDRO A POMPA
PER SERRATURE
ART. 30.600 30.650
DIAM. MM. 30**

103350 MM. 60



**CILINDRO A POMPA
PER SERRATURE
ART. 30.600 30.650
DIAM. MM. 34**

- 103379 MM. 50**
- 103351 MM. 60**
- 103352 MM. 70**
- 103353 MM. 80**
- 103519 MM. 90**
- 103354 MM. 100**



**CILINDRO A POMPA
PER SERRATURE
ART. 30.600 30.650
DIAM. MM. 34
CON CHIAVE PUNZONATA C 10**

- 103520 MM. 50**
- 103521 MM. 60**
- 103522 MM. 70**
- 103323 MM. 80**

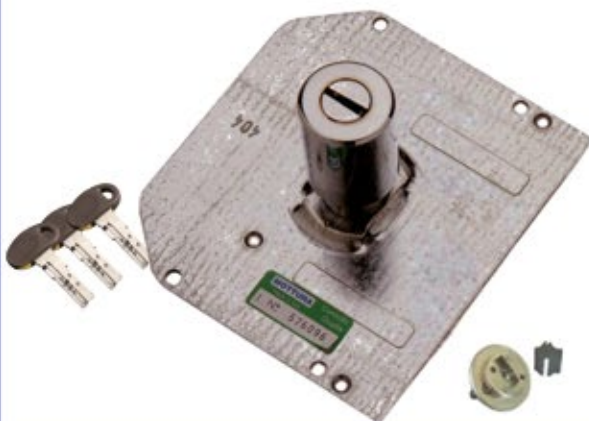

**CILINDRO A POMPA
PER SERRATURE
ART. 30.600 30.650
DIAM. MM. 34
CON CHIAVE PUNZONATA C 28
(PROTETTA)**

- 103525 MM. 50**
- 103526 MM. 60**
- 103527 MM. 70**
- 103528 MM. 80**



**CILINDRO A POMPA
PER SERRATURE
ART. 30E10-30
DIAM. MM. 34
ART. 9129860**

104335 MM. 60 DX



**CILINDRO A POMPA
PER SERRATURE
ART. 30E10-30
DIAM. MM. 34
ART. 9129860**

104336 MM. 60 SX



**CILINDRO A POMPA
PER SERRATURA
CERUTTI CAMPION MM. 30
CON CHIAVE PUNZONATA C28
PROTETTA
ART. 89B111**

104337 DESTRO

104338 SINISTRO



**CILINDRO A POMPA
PER SERRATURA
CERUTTI CAMPION MM. 34
CON CHIAVE PUNZONATA C28
PROTETTA
ART. 89B111**

104339 DESTRO

104340 SINISTRO



**RICAMBIO GORGES
PER SERRATURE**
ART. 52.571-771 / 54.577-587-787
CON 3 CHIAVI MM. 40
ART. 91184107

103373 AMBIDESTRO



**RICAMBIO GORGES
PER SERRATURE**
ART. 52.571-771 / 54.577-587-787
CON 3 CHIAVI MM. 60
ART. 9118410706

103384 AMBIDESTRO



**RICAMBIO GORGES
PER SERRATURE**
ART. 50.555-64.560
CON 3 CHIAVI MM. 40
ART. 91184106

**103495 DESTRO
103496 SINISTRO**



**RICAMBIO GORGES
PER SERRATURE**
ART. 50.555-64.560
CON 3 CHIAVI MM. 60
ART. 9118410606

**104341 DESTRO
104342 SINISTRO**



**RICAMBIO GORGES
PER SERRATURE
ART. 20.500-550
CON 3 CHIAVI MM. 60
ART. 91184102**

**103371 DESTRO
103372 SINISTRO**



**RICAMBIO GORGES EASY GO
PER SERRATURE
ART. 20.500-550
CON 3 CHIAVI MM. 60
ART. 91384102**

**103377 DESTRO
103378 SINISTRO**



**RICAMBIO GORGES EASY GO
PER SERRATURE
ART. 50.555-50.738
CON 3 CHIAVI MM. 40
ART. 91384106**

**103496 DESTRO
103497 SINISTRO**



**RICAMBIO GORGES EASY GO
PER SERRATURE
ART. 54.587-797 SX
ART. 52.571-771 DX SX
CON 3 CHIAVI MM. 40
ART. 91384107**

**104343 DESTRO
103374 SINISTRO**



**RICAMBIO NUCLEO
PER SERRATURE**
ART. 52N571-771 52NR571-771
54N587-787
CON 3 CHIAVI MM. 40
ART. 91057

103425 DESTRO



**RICAMBIO NUCLEO
PER SERRATURE**
ART. 52N571-771 52NR571-771
54N587-787
CON 3 CHIAVI MM. 40
ART. 91057

103426 SINISTRO



**RICAMBIO NUCLEO QUICK
PER SERRATURE**
ART. 52K- 54K
CON 3 CHIAVI MM. 40
ART. 91062B

103433 DESTRO



**RICAMBIO NUCLEO QUICK
PER SERRATURE**
ART. 52K- 54K
CON 3 CHIAVI MM. 40
ART. 91062B

103434 SINISTRO



**RICAMBIO NUCLEO REPLAY
RICIFRABILE
PER SERRATURE SERIE 52Y 54Y
CON 3 CHIAVI MM. 40
ART. 91064B**

103429 DESTRO



**RICAMBIO NUCLEO REPLAY
RICIFRABILE
PER SERRATURE SERIE 52Y 54Y
CON 3 CHIAVI MM. 40
ART. 91064B**

103430 SINISTRO



**RICAMBIO NUCLEO MY KEY
RICIFRABILE CHIAVE PROTETTA
PER SERRATURE
ART.52Y 54Y
CON 3 CHIAVI MM. 40
ART. 91065B**

104344 DESTRO



**RICAMBIO NUCLEO MY KEY
RICIFRABILE CHIAVE PROTETTA
PER SERRATURE
ART.52Y 54Y
CON 3 CHIAVI MM. 40
ART. 91065B**

103430 SINISTRO



**RICAMBIO NUCLEO COMPACT
PER SERRATURE
ART. 52N471
CON 3 CHIAVI MM. 50
ART. 91067**

103427 DESTRO



**RICAMBIO NUCLEO COMPACT
PER SERRATURE
ART. 52N471
CON 3 CHIAVI MM. 50
ART. 91067**

103428 SINISTRO



**DEVIATORE AD INFILARE
PER SERRATURA
A 2 CHIAVISTELLI
ART. 96251/I2**

103435 REVERSIBILE



**LIMITATORE DI APERTURA
AD INFILARE AZIONATO
DA QUADRO MANIGLIA MM. 8
ART. 96093/I**

103436 DX

103437 SX



**ASTE VERNICIATE
PER SERRATURA TRIPLICE
ART.93140**

103364 93140V



**ASTE NERE
PER SERRATURA TRIPLICE
ART. 93140**

103364 93140N

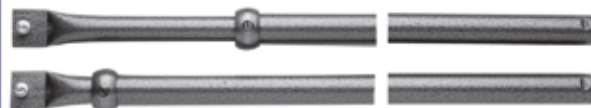

**ASTE BRONZATE
PER SERRATURA TRIPLICE
ART. 93291**

103387 93291



**ASTE VERNICIATE
PER SERRATURA QUINTUPLICE
ART. 93141**

103365 93141V



**DEVIATORE
PER SERRATURA QUINTUPLICE
ART. 96143**

103366 96143V



**DEVIATORE
PER SERRATURA QUINTUPLICE
SERIE 38
ART. 96145**

103388 96145V





**ROSONE DI FINITURA
PER CILINDRO
COMPLETO DI MOSTRINA
ART. 94950**

104053 MM. 50 OTTONATO



**ROSONE DI FINITURA
PER CILINDRO
COMPLETO DI MOSTRINA
ART. 94960**

104054 MM. 60 OTTONATO



**MEZZO GIRO ROVESCIATO
PER SERRATURE SERIE 500
ART. 99135**

103369 DESTRO

103370 SINISTRO



**MEZZO GIRO ROVESCIATO
PER SERRATURE SERIE 600
ART. 99135**

104346 DESTRO

104367 SINISTRO



**BOCCOLA A PAVIMENTO
PER ASTE MM. 18
ART. 99151**

103360 OTTONATA



**SBALZI PER ASTE
VERNICIATE
ART. 99137-38**

**103361 CM. 3
103362 CM. 7
103363 CM. 10**



**FERROGLIERA
PER SERRATURE ART. 40701-705
ART. 94282**

104450 ZINCATA



**TESTA PLASTICA
PER CHIAVE
ART. 98135**

**104451 NERA
104452 BLU**



**MOSTRINA PER SERRATURE
A CILINDRO EUROPEO
E FORO MANIGLIA
MM. 62X180
ART. 95172**

104453 OTTONATA
104454 BRONZATA
104455 ARGENTO



**MOSTRINA PER SERRATURE
A CILINDRO EUROPEO
MM. 65X90
ART.95417**

104456 OTTONATA
104457 BRONZATA
104458 ARGENTO



**MOSTRINA ESTERNA
PER SERRATURE DOPPIA MAPPA
AMBIDESTRA
MM. 52X70
ART. 95323**

104459 OTTONATA
104460 BRONZATA
104461 ARGENTO



**MOSTRINA INTERNA
PER SERRATURE DOPPIA MAPPA
AMBIDESTRA
MM. 52X70
CON COPRITOPPA IN PLASTICA
ART. 95324**

104462 OTTONATA
104463 BRONZATA
104464 ARGENTO



**MOSTRINA ESTERNA
PER SERRATURE
DOPPIA MAPPA
AMBIDESTRA MM. 52X70
ART. 95315**

104465 OTTONATA
104466 BRONZATA
104467 ARGENTO



**MOSTRINA COPRIFORO
MM. 52X70
ART. 95246**

104468 OTTONATA
104469 BRONZATA
104470 ARGENTO



**MOSTRINA ESTERNA
CONCAVA PER SERRATURE
DOPPIA MAPPA
AMBIDESTRA MM. 65X90
ART. 95344**

103375 MM. 10 OTTONATA
103376 MM. 15 OTTONATA
104471 MM. 10 CROMATA
104472 MM. 15 CROMATA



**MOSTRINA ESTERNA
CONCAVA PER SERRATURE
DOPPIA MAPPA
AMBIDESTRA MM. 65X90
ART. 95344/4-5**

104473 MM. 10 OTTONATA
104474 MM. 15 OTTONATA
104475 MM. 10 CROMATA
104476 MM. 15 CROMATA



**MOSTRINA ESTERNA
PER SERRATURE A POMPA
MM. 52X64 MM. 34
ART. 95148**

103396 CROMATA



**MOSTRINA ESTERNA
CONCAVA PER SERRATURE
A POMPA MM. 65X90 MM 34
ART. 95345**

**104477 MM. 10 OTTONATA
104478 MM. 10 CROMATA**



**MOSTRINA INTERNA
PER CILINDRI CON POMOLO
MM. 52X70
ART. 95321**

**104479 OTTONATA
104480 BRONZATA
104481 ARGENTO**



**MOSTRINA IN FERRO
PER SERRATURA DOPPIA MAPPA
MM. 40X65
ART. 95281**

104482 ZINCATA





MADE
IN
ITALY

CHAMPIONS MC28PLUS

HIGH SECURITY CYLINDERS



CERTIFIED UNI EN 1303-05



SICUREZZA "MATEMATICA" + X - / ED ELEMENTO MOBILE A PROTEZIONE DUPLICATI

Chiavi con profilo brevettato MM e controlli profilo "in Asse" laterali e sagomati, brevettati, più elemento mobile. Duplicazione protetta, consentita solo presso Centri Autorizzati Mottura Club



safeguarding your security



Siamo grandi in ogni dettaglio.



Sicurezza, affidabilità, prestazioni.

I cilindri svolgono da sempre un ruolo determinante nella protezione dei luoghi in cui viviamo. L'attenzione che poniamo su ogni dettaglio ci permette di offrire al mercato cilindri sicuri, affidabili e con prestazioni idonee alla realizzazione di tutti i sistemi di gestione degli accessi.



CILINDRI E CHIAVI



SERRATURE



CONTROPASTRE



MANIGLIONI A TRARRANCO





**SERRATURA PER FASCE
SCROCCO REVERSIBILE
2 MANDATE**

160009 ART.390/60
160010 ART.790/70
160012 ART.890/80



FRONTALE 16 MM
ALTEZZA SCATOLA 44 MM

CONF. IND. CON CILINDRO

**SERRATURA PER FASCE
SCROCCO REVERSIBILE
2 MANDATE**

160005 ART.380/60
160006 ART.780/70
160024 ART.880/80



FRONTALE 16 MM
ALTEZZA SCATOLA 64 MM

**SERRATURA PER FASCE
SCROCCO REVERSIBILE
3 MANDATE**

160000 ART.370/60
160001 ART.770/70
160025 ART.870/80



FRONTALE 16 MM
ALTEZZA SCATOLA 78 MM

CONF. IND. CON CILINDRO

**ELETTROSERR.PER FASCE
SCROCCO
ENTRATA MM. 60**

160013 ART.399 DX
160014 ART.399 SX

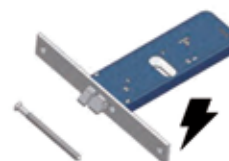

FRONTALE 16 MM
ALTEZZA SCATOLA 44 MM

**ELETTROSERR. PER FASCE
SCROCCO REVERSIBILE**

160015 ART.799/70
160016 ART.899/80



FRONTALE 16 MM
ALTEZZA SCATOLA 44 MM

**ELETTROSERR.PER FASCE
SCROCCO REVERSIBILE
1 MANDATA**

160007 ART.388/60
160008 ART.788/70
160023 ART.888/80

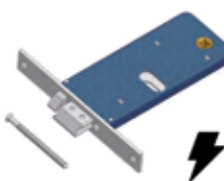

FRONTALE 16 MM
ALTEZZA SCATOLA 64 MM

**ELETTROSERR.PER FASCE
SCROCCO REVERSIBILE
1 MANDATA**

160002 ART.377/60
160021 ART.777/70
160022 ART.877/80



FRONTALE 16 MM.
ART. 377 ALT. SCAT. MM.84
ART.777-877 ALT. SCAT. MM. 78

**ELETTROSERR.PER FASCE
SCROCCO
2 MANDATE
ENTRATA MM 60**

160003 ART. 378 DX
160004 ART. 378 SX



FRONTALE 16 MM.
ALTEZZA SCATOLA 84 MM.

**CONTROPIASTRA IN NYLON
ART.04061N**

160030 MM. 150X40

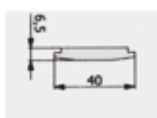

**CONTROPIASTRA IN NYLON
ART. 02381N**

160031 MM. 150X22



**CONTROPIASTRA
ACCIAIO INOX ART. 02524X**

160032 MM. 135X25

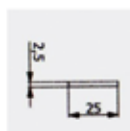
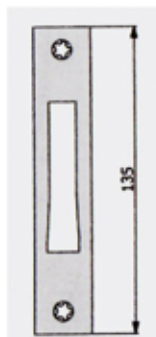

**CONTROPIASTRA
ACCIAIO INOX ART. 02528X**

160033 MM. 180X25

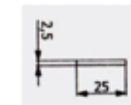







Potent

Potent

**SERRATURA SERRANDA
CHIAVE PIATTA**

103128 CENT.



**SERRATURA SERRANDA
CHIAVE PIATTA
COPPIA**

103129 LAT.

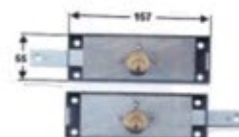
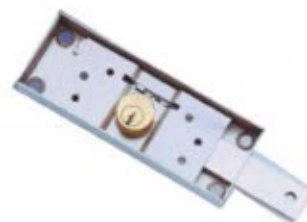

**SERRATURA SERRANDA
DOPPIA MAPPA**

103126 CENT.



**SERRATURA SERRANDA
DOPPIA MAPPA
COPPIA**

103127 LAT.

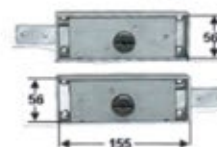

SERRATURA PER CANCELLETTI

103215 VERTICALE



SERRATURA BASCULANTE

103125 D.MAPPA

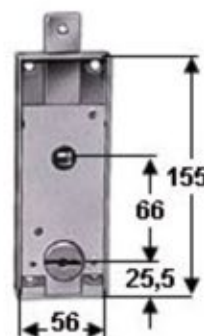



**SERRATURA PER BASCULANTE
CILINDRO TONDO**

103210 ART. 1640



**SERRATURA PER BASCULANTE
CILINDRO SAGOMATO
C/LEVA SBLOCCO**

103211 ART. 1640E



**SERRATURA APPLICARE
TRIPLICE A POMPA MM. 60
ART. N 520**

104420 DX

104421 SX



**SERRATURA APPLICARE
TRIPLICE DOPPIA MAPPA
ART. N 930**

104422 DX

104423 SX



**CILINDRO A POMPA
ART. 596 N
VECCHIA SERIE
COMPLETO DI PIASTRA**

103701 MM. 60

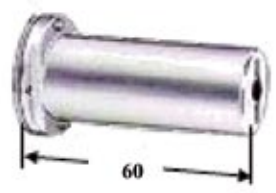

**CILINDRO A POMPA
ART. 596 TN
NUOVA SERIE**

103700 MM. 60

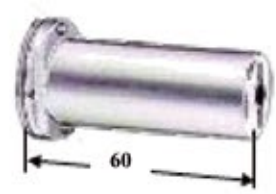



Potent

Potent

**SERRATURA DOPPIA MAPPA
ART. 1840/28**

103702 DX

103703 SX

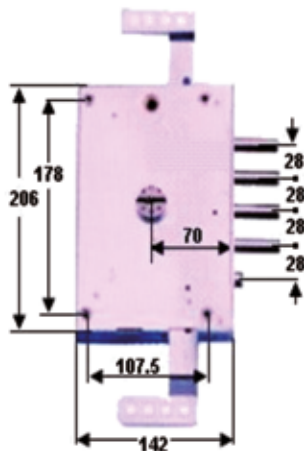

**SERRATURA DOPPIA MAPPA
ART. 1840/37**

103704 DX

103705 SX

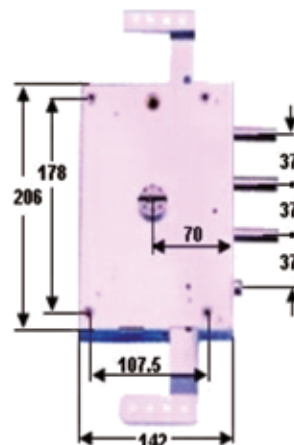

**SERRATURA DOPPIA MAPPA
ART. 1900N4**

103706 DX

103707 SX

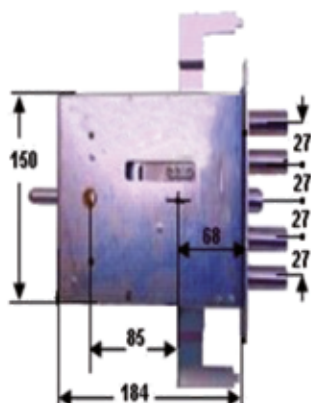

**SERRATURA DOPPIA MAPPA
ART. 1900N4B**

103708 DX

103709 SX

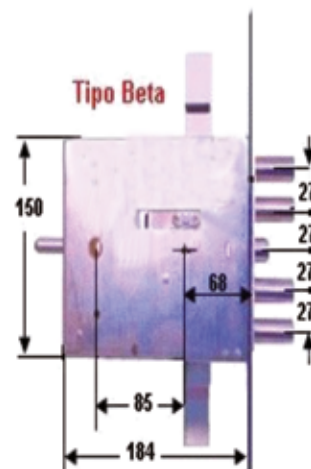

**SERRATURA INFILARE
CON PRED.CILINDRO EUROPEO
ART. 1900N4/CIL**

103770 DX

103771 SX

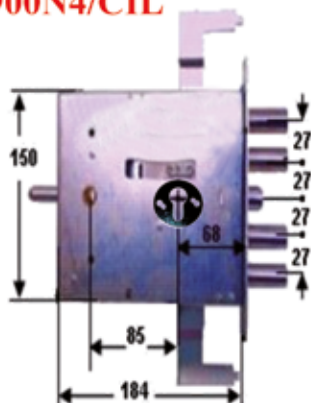

**SERRATURA INFILARE
CON PRED.CILINDRO EUROPEO
ART. 1900N4B/CIL**

103772 DX

103773 SX

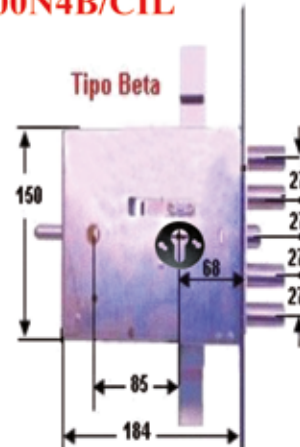

**COMPLETA DI DEFENDER E PLACCA
INTERNA OTTONATE**

**COMPLETA DI DEFENDER E PLACCA
INTERNA OTTONATE**

**RICAMBIO GORGES
PER SERIE 900
ART. 997**

**103760 DX
103761 SX**



**RICAMBIO GORGES
PER SERIE 1900
ART.1829**

**103762 DX
103763 SX**



**RICAMBIO GORGES
PER SERIE 1840
ART. 1827**

103764 AMBIDESTRO



**MANIGLIA MARTELLINA
PER BASCULANTE**

103212 MM. 25-35



**PLACCA COPRIFORO
BASCULANTE**

103214 CIL. SAGOM.



**PLACCA COPRIFORO
BASCULANTE**

103213 CIL. TONDO







***Serrature
con cilindri
di sicurezza***





**SERRATURA PER SERRANDA
CON CHIAVE PUNZONATA**

103201 CENTRALE



**SERRATURA E LUCCHETTO
C/ CHIAVE UNICA PUNZONATA**

103202 SET



SERRATURA PER BASCULANTE

103565 CILINDRO SAGOMATO



SERRATURA PER BASCULANTE

103566 CILINDRO TONDO



SERRATURA PER BASCULANTE

103567 CILINDRO D. MAPPA



**SERRATURA PER SERRANDA
DOPPIA MAPPA**

103568 CENTRALE

103569 CENTRALE KA





S.a.b.
SERRATURE



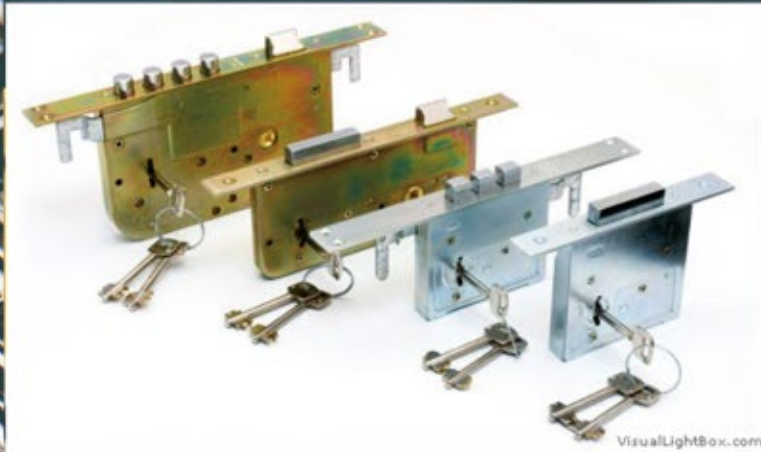

S.A.B. formed in 1976; in these years it has been specialized in security locks and accessories: locks with bitted keys, multipoint, with gear movement, for security doors, for profile cylinder and rosettes.

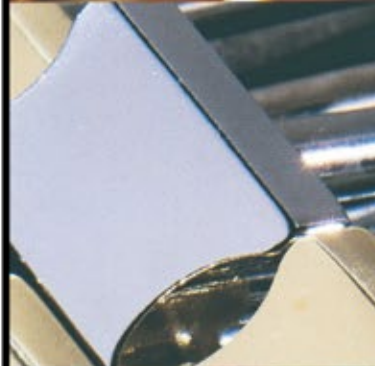

The S.A.B. mark is characterized on the market for high-quality of materials and finishings

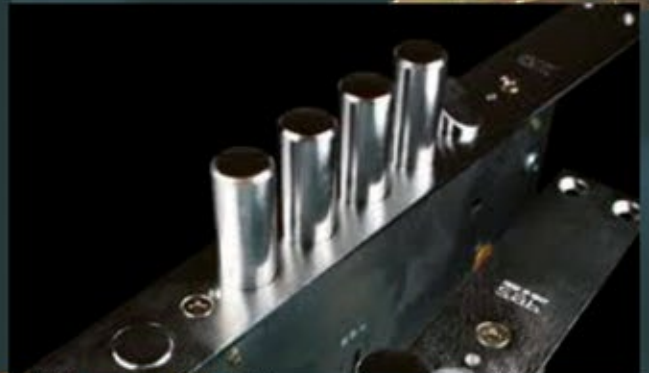



**SERRATURA DOPPIA MAPPA
INFILARE 2 MANDATE
C/2 CHIAVI
ART.4000**

103276 ENT. 40
103277 ENT. 50
103278 ENT. 60



**SERRATURA DOPPIA MAPPA
INFILARE 2 MANDATE
C/1 CHIAVE
ART. 4000 KA CHIAVE UNICA**

103500 ENT. 40
103501 ENT. 50
103502 ENT. 60



**SERRATURA DOPPIA MAPPA
INFILARE 4 MANDATE
C/2 CHIAVI
ART 450 R**

103280 ENT. 50
103281 ENT. 60
103282 ENT. 70

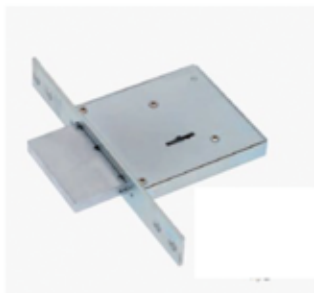

**SERRATURA DOPPIA MAPPA
INFILARE 4 MANDATE
C/1 CHIAVE
ART 450 R KA CHIAVE UNICA**

103300 ENT. 50
103301 ENT. 60
103302 ENT. 70

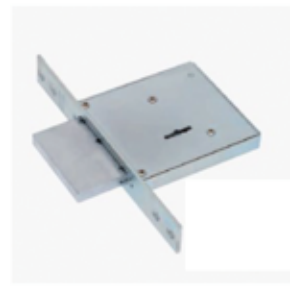

**SERRATURA DOPPIA MAPPA
INFILARE 2 MANDATE
C/3 CHIAVI
ART. 500/90**

103295 ENT. 40
103296 ENT. 50
103297 ENT. 60



**SERRATURA DOPPIA MAPPA
INFILARE 4 MANDATE
C/2 CHIAVI
ART.610/2**

103304 ENT. 50
103305 ENT. 60
103306 ENT. 70

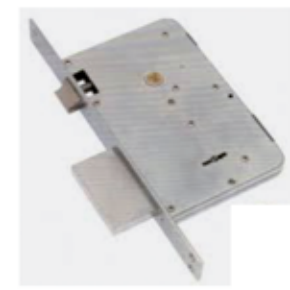



**SERRATURA DOPPIA MAPPA
TRIPLICE A 4 MANDATE
C/3 CHIAVI
ART. 600/3**

103319 ENT.60



**SERRATURA DOPPIA MAPPA
INFILARE 4 MANDATE
C/3 CHIAVI
ART. 654**

103309 ENT. 60



**SERRATURA DOPPIA MAPPA
INFILARE 4 MANDATE
TRIPLICE C/3 CHIAVI
ART. 634/3**

103285 ENT. 60



**SERRATURA DOPPIA MAPPA
INFILARE 4 MANDATE
C/3 CHIAVI
ART.1560/28**

103310 REVERS.

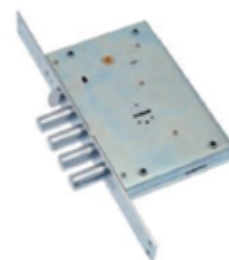

**SERRATURA DOPPIA MAPPA
INFILARE 4 MANDATE
C/3 CHIAVI TRIPLICE
ART.1561/28**

103311 REVERS.



**SERRATURA DOPPIA MAPPA
INFILARE 4 MANDATE
TRIPLICE C/3 CHIAVI
ART.1563/28**

103317 REVERS.

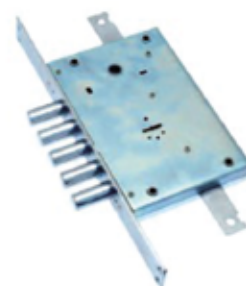



**SERRATURA DOPPIA MAPPA
INFILARE 4 MANDATE
DOPPIA CHIUSURA C/3+3 CHIAVI
TRIPLICE ART. 1600/28**

103312 REVERS.



**SERRATURA DOPPIA MAPPA
INFILARE 2 MANDATE
TRIPLICE C/3 CHIAVI
ART. 520/3**

103318 ENT. 50



**SERRATURA DOPPIA MAPPA
INFILARE 2 MANDATE
MULTIPUNTO S/FRONTALE
ART.580**

**103530 ENT. 45
103531 ENT. 50
103532 ENT. 60**



**CONTROPIASTRE
ZINCATE**

103290 PER ART. 450

103239 PER ART. 4000

BOCCHETTE

103315 OTT.LUC.

103316 ZINCATA



**SERRATURA INFILARE
3 MANDATE
CON CILINDRO SAGOMATO
ART.610Y**

**103540 ENT. 60
103541 ENT. 70**



**SERRATURA INFILARE
3 MANDATE
CON CILINDRO SAGOMATO
TRIPLICE ART.600Y**

103542 ENT. 60





**CHIAVE DOPPIA MAPPA
ORIGINALE SAB**

103288 ART. 53



**CHIAVE DOPPIA MAPPA
ORIGINALE SAB**

103289 ART. 53 L



**CHIAVE DOPPIA MAPPA
ORIGINALE SAB
TESTA PLASTICA NERA**

103291 ART. 202

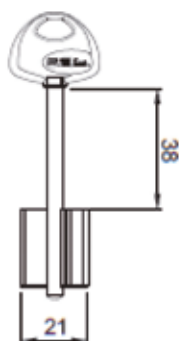

**CHIAVE DOPPIA MAPPA
ORIGINALE SAB
TESTA PLASTICA NERA**

103292 ART. 202L

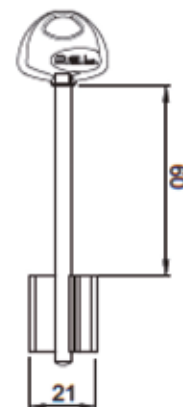

**CHIAVE DOPPIA MAPPA
ORIGINALE SAB
TESTA PLASTICA ROSSA**

103543 ART. 202 C



**CHIAVE DOPPIA MAPPA
ORIGINALE SAB
TESTA PLASTICA ROSSA**

103544 ART. 202 L

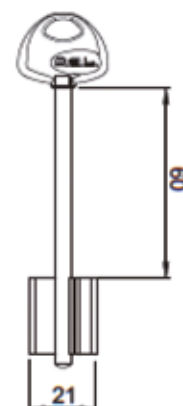



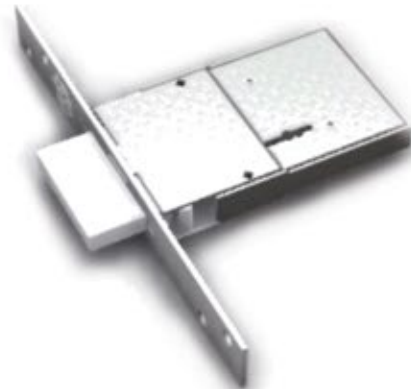

**SERRATURA ART. 2000
4 MANDATE**

104350 MM.50
104351 MM.60
104352 MM.70

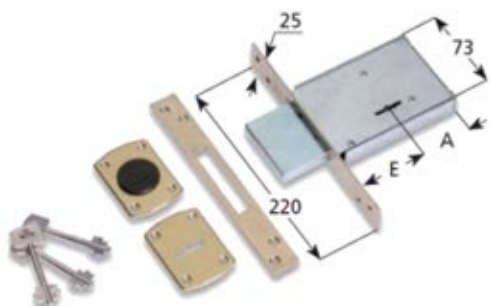

**SERRATURA ART. 2000
4 MANDATE KA 1 CHIAVE**

104375 MM. 50
104353 MM. 60
104354 MM. 70

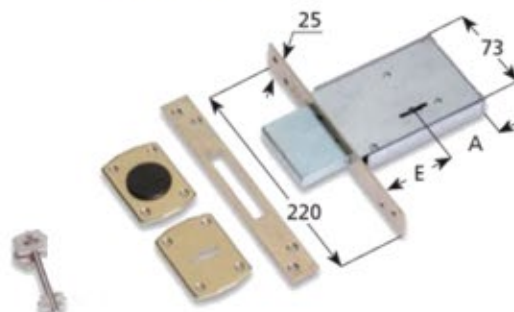

**SERRATURA ART.2003
4 MANDATE TRIPLICE**

104376 MM. 50
104355 MM. 60
104356 MM. 70



**SERRATURA ART. 2001
2 MANDATE**

104377 MM. 50
104378 MM. 60
104379 MM. 70



**SERRATURA ART. 2010
4 MANDATE E SCROCCO**

104359 MM. 70
104360 MM. 90



**SERRATURA ART. 2008
4 MANDATE E SCROCCO
TRIPLICE**

104357 MM. 70
104358 MM. 90





**SERRATURA ART. 250
DOPPIA MAPPA
CON SECURMAP
DISTANZA PISTONI MM 28**

104363 DX

104364 SX



**SERRATURA ART. 250
DOPPIA MAPPA
CON SECURMAP
DISTANZA PISTONI MM 37**

104365 DX

104366 SX



**SERRATURA ART.260
CON PREDISPOSIZIONE
CILINDRO EUROPEO
DISTANZA PISTONI MM 28**

104367 DX

104368 SX



**SERRATURA ART.260
CON PREDISPOSIZIONE
CILINDRO EUROPEO
DISTANZA PISTONI MM 37**

104369 DX

104370 SX



**SERRATURA ART. 2017
2 MANDATE E SCROCCO
REVERSIBILE**

104361 MM. 45



**SERRATURA ART.2018
2 MANDATE E SCROCCO
TRIPLICE
REVERSIBILE**

104362 MM. 45



**CUORE DI RICAMBIO
CILINDRO ART. 25 TX
ADATTATORE DA DOPPIA MAPPA
A PREDISPOSIZIONE
CIL. EUROPEO**

104373 DX

104374 SX



**CUORE DI RICAMBIO
DOPPIA MAPPA
SECURMAP ART. 25 SX**

104371 DX

104372 SX





WWW.SA.ME.FERRAMENTA.COM





Vuoi una cassaforte o un armadio di sicurezza su misura?

Richiedi QUI
un preventivo

Viro® LO FA!

Resterai
positivamente
sorpreso! 😊

Scegli la versione:

da murare

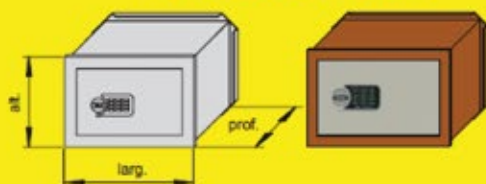

da mobile



meccanica

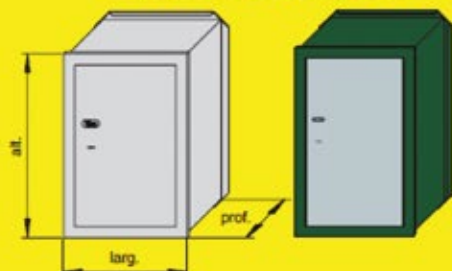

elettronica

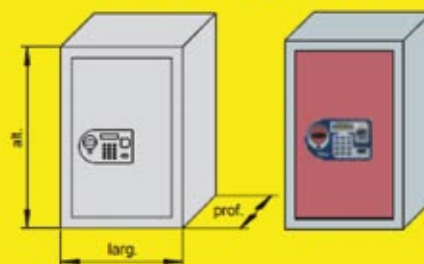

e personalizza dimensioni, robustezza e colori!



Fornisci le misure desiderate
oppure indica semplicemente
lo spazio a tua disposizione e
**Viro proporrà la soluzione
più adatta alle Tue esigenze!**

Opzioni disponibili:

- porta che si apre verso sinistra;
- più ripiani porta oggetti;
- modulo d'illuminazione interna.



www.viro.it



**“VAN LOCK”
GRUPPO DI FISSAGGIO
PER FURGONI CAMION**

104730 VAN LOCK 4222



**104731 VAN LOCK 4222-4222
KIT 2 PZZ. CHIAVE UNICA**

Viro®



**ELETTROSERRATURA
APPLICARE
ENTRATA REGOLABILE
50-60-70-80**

104735 ART.9083



VUOI APRIRE SERRATURE, CILINDRI E LUCCHETTI CON LA STESSA CHIAVE ?



Spranga Universale art. 4008
con mezzo cilindro art. 773.9



Serratura da infilare art. 7435.50.2.046
con doppio cilindro art. 723 e rosetta
di sicurezza art. 808.046



Nuove Condar art. 1.4218 con
mezzo cilindro art. 1.772



Serratura corazzabile per basculanti
art. 8234 con mezzo cilindro art. 1.772.9
e rosetta di sicurezza art. 806



Serratura elettrica V9083 per
cancelli automatici



Serratura elettrica "Block-Out"
per cancelli pedonali



Serratura elettrica V09 per
cancelli scorrevoli



Tutti i prodotti di sicurezza utilizzati nelle diverse applicazioni qui rappresentate, ad es. possono essere comandati dalla stessa chiave art. 015 (anche a profilo brevettato), oppure far parte di un sistema a chiave maestra MK (tipo passepartout).

SISTEMI SPECIALI A CHIAVE MAESTRA

CHIAVI DIVERSE KD
Ogni porta viene aperta da
una chiave diversa.



CHIAVI MAESTRE A GRUPPI
(MKa, MKb, MKc)
Più gruppi di porte con chiavi diverse
(KDa, KDb, KDc) possono essere aperte
da una sola chiave maestra per gruppo.

Esiste inoltre la possibilità che tutte, o
parte delle chiavi sopraindicate, aprano
un ingresso comune, ottenendo così un
sistema a cilindro centrale (CC).



**CHIAVE MAESTRA
GENERALE GMK**
Tutte le porte che formano
questi gruppi possono
essere aperte da una sola
chiave detta chiave maestra
generale.

www.viro.it



Dal 1925 - Since 1925



www.wallyserrature.it

**SERRATURA DA PORTONCINO
DA APPLICARE
C/CIL. FISSO 2-3 MANDATE
ART. 310/A**

- 103043 ENT. 40DX
- 103047 ENT. 40SX
- 103044 ENT. 50DX
- 103048 ENT. 50SX
- 103045 ENT. 60DX
- 103049 ENT. 60SX
- 103046 ENT. 70DX
- 103050 ENT. 70SX

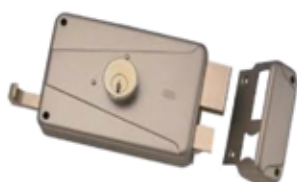

**SERRATURA DA PORTONCINO
DA APPLICARE C/POMOLO INT.
C/CIL STACCATO 2-3 MAND.
ART 330/B**

- 103055 E. 40X80 DX
- 103056 E. 50X100 DX
- 103057 E. 60X120 DX
- 103058 E. 70X140 DX



**SERRATURA DA PORTONCINO
DA APPLICARE
C/FORO MANIGLIA CIL. FISSO
2-3 MANDATE
ART.600/A**

- 103036 E. 50 DX
- 103037 E. 50 SX
- 103020 E. 60 DX
- 103021 E. 60 SX



**SERRATURE INFILARE
A 2 MANDATE B.RETTO OTT.
C/CIL. ART. 60/2 (MM.58 D)
ART. 262**

- 103069 ENT. 25
- 103070 ENT. 30
- 103071 ENT. 35
- 103072 ENT. 40
- 103073 ENT. 45
- 103074 ENT. 50
- 103075 ENT. 60
- 103076 ENT. 70
- 103077 ENT. 80



**SERRATURE INFILARE
A 2 MANDATE B.RETTO OTT.
C/CIL. ART. 60/2 (MM.58 D)
ART. 263**

- 103080 ENT. 30
- 103081 ENT. 35
- 103082 ENT. 40
- 103083 ENT. 45
- 103084 ENT. 50
- 103085 ENT. 60



**SERRATURE INFILARE
A 2 MANDATE B.TONDO OTT.
C/CIL. ART. 60/2 (MM.58 D)
ART. 262**

- 103062 ENT. 45
- 103063 ENT. 50
- 103064 ENT. 60



**SERRATURA INFILARE
PER TAGLIAFUOCO
ART. 269
ANTIPANICO REVERSIBILE**

103060 ACCIAIO C.



**SERRATURA INFILARE
PER TAGLIAFUOCO
ART. 268
CON PERNI REVERSIBILE**

103061 ACCIAIO C.



**FERROGLIETTO
CILINDRO FISSO GIRI 6
ART. 270/A**

- 103000 ENT. 40**
- 103001 ENT. 50**
- 103002 ENT. 60**
- 103003 ENT. 70**

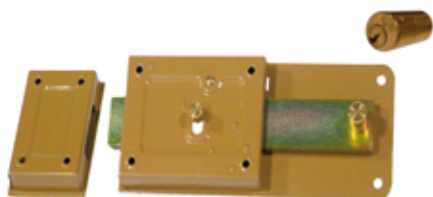

**FERROGLIETTO
CILINDRO STACCATO GIRI 6
ART. 270/B**

- 103004 ENT. 40**
- 103005 ENT. 50**
- 103006 ENT. 60**
- 103007 ENT. 70**

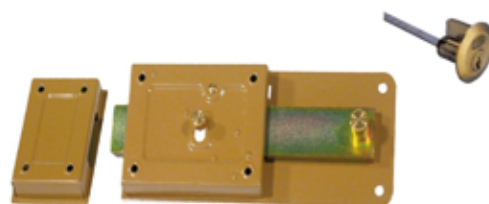

**FERROGLIETTO
CILINDRO FISSO GIRI 5 1/2
ART. 270 BIS/A**

- 103010 ENT. 40**
- 103011 ENT. 50**
- 103012 ENT. 60**
- 103013 ENT. 70**

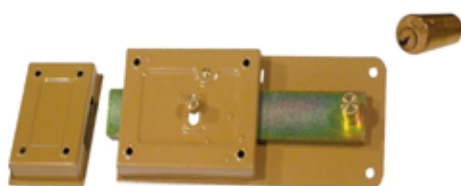

**FERROGLIETTO
CILINDRO STACCATO GIRI 5 1/2
ART. 270 BIS/B**

- 103014 ENT. 40**
- 103015 ENT. 50**
- 103016 ENT. 60**
- 103017 ENT. 70**

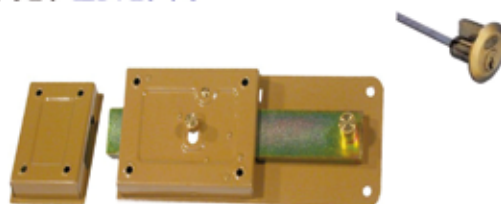

**FERROGLIETTO
CON SCROCCO SEPARATO
CILINDRO FISSO GIRI 6
ART. 281/A**

103023 ENT. 50
103024 ENT. 60
103025 ENT. 70



**FERROGLIETTO
CON SCROCCO SEPARATO
CILINDRO STACCCATO GIRI 6
ART. 281/B**

103028 ENT. 50
103029 ENT. 60
103030 ENT. 70



**FERROGLIETTO
CON SCROCCO SEPARATO
CILINDRO FISSO GIRI 6
ART. 281/A
CNF . INDUSTRIALE**

103053 ENT. 50
103054 ENT. 60



**FERROGLIETTO
CON SCROCCO SEPARATO
CILINDRO STACCCATO GIRI 6
ART. 281/B
CNF . INDUSTRIALE**

103051 ENT. 50
103052 ENT. 60



**FERROGLIETTO
CON SCROCCO SEPARATO
DOPPIO CILINDRO GIRI 6
CILINDRO ESTERNO FISSO
ART. 282/A**

103032 ENT. 50
103033 ENT. 60
103034 ENT. 70



**SERRATURA A GANCIO PER
PORTE SCORREVOLI
ART. 267**

103018 ENT. 60







SERRATURE
PER SERRAMENTI
IN LEGNO
*LOCKS FOR
WOODEN DOORS*



SERRATURE
PER SERRAMENTI
IN FERRO
*LOCKS FOR
STEEL DOORS*



SERRATURE
PER SERRAMENTI
IN ALLUMINIO
*LOCKS FOR
ALUMINIUM
PROFILE*



ELETTROSERRATURE
PER CANCELLI
*ELECTRIC
LOCKS*



CHIAVI
E CILINDRI
*KEYS AND
CYLINDERS*

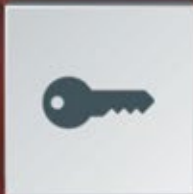

ACCESSORI
ACCESSORIES

**SERRATURA AD APPLICARE
DA PORTONCINO
DESTRA**

103850 MM. 50
103851 MM. 60
103852 MM. 70



**SERRATURA AD APPLICARE
DA PORTONCINO
SINISTRA**

103853 MM. 50
103854 MM. 60
103855 MM. 70



**SERRATURA INFILARE
BORDO RETTO OTTONATO
C/CILINDRO**

103860 MM.40
103861 MM.45
103862 MM.50



**SERRATURA INFILARE
BORDO TONDO OTTONATO
C/CILINDRO**

103870 MM. 50



**SERRATURA INFILARE
BORDO RETTO CROMATO
C/CILINDRO**

103875 MM. 50



**SERRATURA INFILARE
BORDO TONDO CROMATO
C/CILINDRO**

103880 MM.50



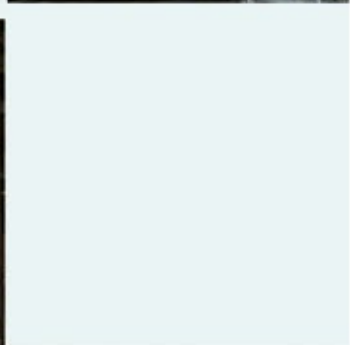
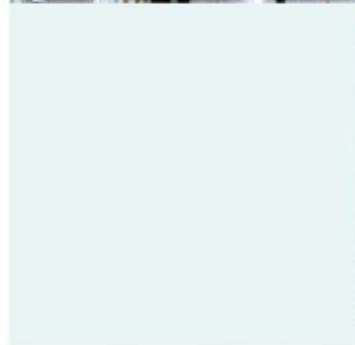
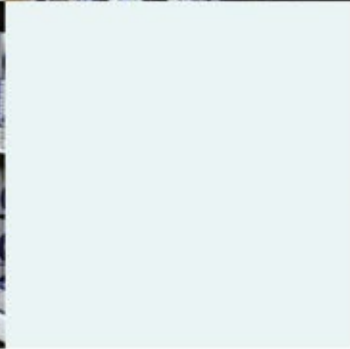
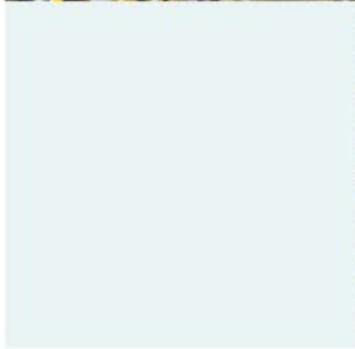

WWW.SAMEFERRAMENTA.COM